

# Kinderlogo

**Creative Math Activities for Young Learners**

## 52 Ideas for Kinderlogo

Fun and educational ways to explore  
Kinderlogo with children ages 4-8.



by Kinderlogo author,  
Dorothy M. Fitch

© 2024

# Introduction

This booklet is designed to give teachers (or parents at home) many ideas for using Kinderlogo with their children. This is, of course, not a comprehensive list of ideas, just some projects to get you started.

Some of the ideas make use of the ready-made Kinderlogo activities, and others are inventions of my own. There are many activities at Level 1, as that is where all students start. There are easy activities for Kindergarten students, and more complicated ones for older children. You can advance them to higher levels as you see fit. Use the information in Kinderlogo's Teacher Center as a guide.

Of course, you will want to give your students plenty of opportunities to play with the turtle on their own, and not be tasked with a particular project. However, those who like more structure can follow these activities.

There are plenty of activities here to keep your students occupied for years. They won't do all the activities in one year. They can also come back to their favorite activities.

There are two sets of activities. The first set is aimed at the teacher, with helpful tips on using the activities. The second set of activity pages are designed for the student, with minimal text to read. Use them if you like. At the end is a checklist, which allows each student to keep a record of the activities he or she has done.

**Printing Suggestion:** For best results when printing this booklet, set your printer to print **2 Pages per Sheet** or choose the **Booklet** option.

Thank you to my wonderful and creative students at Sahuarita Primary School in Sahuarita, AZ, who created most of these pictures. They never ceased to amaze me with what they did with Kinderlogo. We also did other activities in the computer lab, but when they were given free choice of any activity (typically just before vacations), a great many of them did Kinderlogo activities!

Enjoy your Kinderlogo adventures!

Dorothy Fitch

# Contents

## Level 1

1. Meet the Turtle
2. Exploring with the Turtle
3. Balloon Game
4. Mazes
5. Building a Square
6. Making Other Shapes
7. Kinderlogo Alphabet
8. Make a Star
9. Square Corner Day
10. Turtle Dance
11. Build a House
12. Color Grid: Explore
13. Hearts!
14. Stairs
15. Tower of Boxes
16. Spirals
17. Perimeters
18. Stencil Letters
19. Snaky Curves

## Level 2

20. Patterns with Squares
21. Make a Vehicle
22. Patterns with Circles
23. Backward Maze
24. Color Grid: Holidays
25. Stick Figures
26. Flower Patterns
27. Five Squares
28. Beads

29. Half and Half
30. Quarters
31. A Village
32. Letter Dots

## Level 3

33. Hello, My Name Is...
34. Patterns Everywhere!
35. Animals
36. Free Time
37. Target Game
38. Tic-Tac-Toe

## Level 4

39. Colored Lines
40. Colored Shapes
41. Multiplication & Area
42. Flags of the World
43. Mirror
44. Turtle Time
45. Color Grid: Graph Paper
46. Lollipops!
47. Symmetry

## Level 5

48. Sizes
49. Teach the Turtle
50. Picture Pairs
51. Logic Game
52. Snowflakes

## Activity Checklist

# Level 1

Level 1 is the place for all children to start, regardless of their age or grade. They need to explore with the turtle with a minimum of commands to learn how to control it.

Here are the Level 1 commands.

- |          |         |   |
|----------|---------|---|
| <b>F</b> | Forward | Move the turtle straight ahead 10 steps.                                |
| <b>R</b> | Right   | Rotate the turtle 30 degrees to the right.                              |
| <b>L</b> | Left    | Rotate the turtle 30 degrees to the left.                               |
| <b>X</b> | Erase   | Erase the last command typed.<br>The Backspace key has the same effect. |
| <b>N</b> | New     | Start a new picture (confirm with Yes).                                 |

Press \* to quickly save the screen image to your Downloads folder.

Start with the **Exploring Level 1** activity so that students can try out the new commands.

Unless otherwise noted, you will use this activity for all the ideas in the Level 1 section,

# 1 • Meet the Turtle

Let's play turtle! What can a turtle do? Choose a child to be the turtle and have them stand in the middle of the room.

Can someone tell this turtle [the child] something to do?

Can it go straight ahead? Can it turn?

Can it get to the door?

Have students take turns telling the "turtle" what to do by giving commands.

Go to **Level 1** and click on **Explore Level 1**.

There's a turtle we can play with.



How do you think we get this turtle to do something?

Here's a hint. We can give it commands by typing letters on the keyboard. We won't use the arrow keys, but the keys with letters on them.

Which letter might tell it to go straight ahead? Can the children think of the **F** key for Forward?

Which letter might tell it to turn in one direction, and which letter to turn the other way? How about **R** for Right and **L** for Left?

What if you make a mistake? That's OK. Just press **X** and your last letter will be erased.

Practice moving and turning the turtle.

## 2 • Exploring with the Turtle

The first pictures that the children will draw will be very exploratory and experimental. They are seeing what happens when they move the turtle around the screen, even off the edge of the screen. (The turtle wraps around to the other side, where it reappears.)

Their pictures will be big and likely not recognizable. Resist the temptation to ask them to “draw something.” Smaller, more representation pictures will come in time after they finish experimenting.

When a child first holds a crayon, she doesn’t draw a nice picture. She first scribbles to see what the crayon can do. The same thing happens with the turtle.

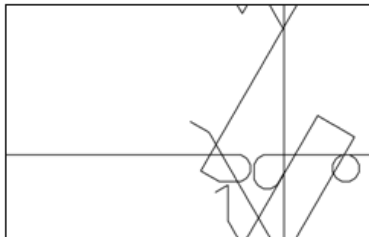
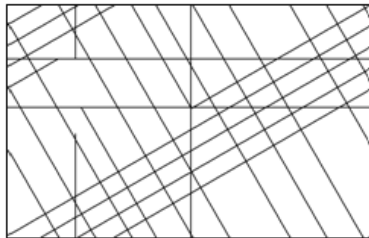
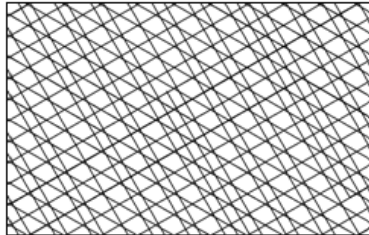

## 3 • Balloon Game

After the children have a good sense of how to get the turtle to go where they want it to, have them try the **Balloon** game. This activity is in the Level 1 section.

When the activity starts, a colorful circle (the balloon) appears somewhere on the screen. The goal is to move the turtle to the center of the balloon to “pop” it.

When the balloon “pops,” you’ll hear a tune.

After the child pops a balloon, another one appears. After a half dozen or so balloons are popped, ask the children what is changing about each new balloon.

They will first tell you that its color changes, which is true. Eventually, one of them will notice that the balloons are getting smaller and smaller! The last ones are quite tricky to pop!

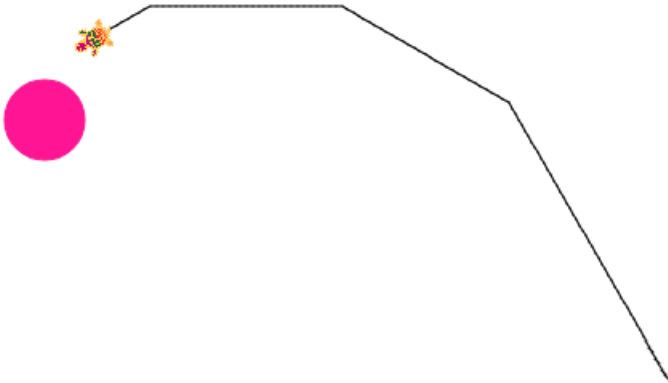

## 4 • Mazes

Another way to practice maneuvering the turtle is to use the Level 1 Mazes. There are three mazes, each one slightly more difficult.

**Maze 1** is an exploratory maze. There is no “end” to reach. Have the students try to move the turtle on every white road in the maze.



In **Maze 2**, the turtle starts at the left edge. Children move it to the right edge, where a tune plays when they reach it.

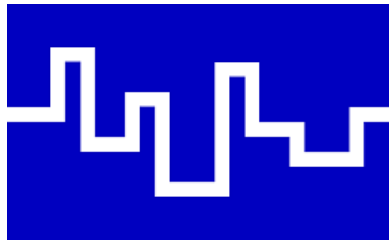

In **Maze 3**, students move the turtle to the red target (circle).

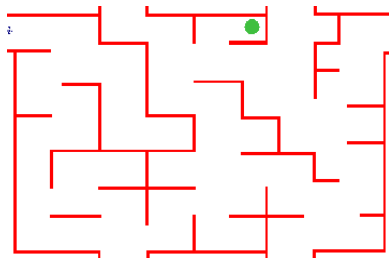

If they touch a red wall, their turtle gets sent back to the beginning, so they have to “drive” the turtle extra carefully in this maze!



## 5 • Building a Square

Have the children spent lots of time drawing designs, scribbles, and pictures. Soon they will be ready to make some shapes.

All your students, regardless of their grade, will start at Level 1. The older ones will soon be ready to draw a square.

Challenge your students to draw a square. They will generally turn the right angles correctly, but not be as careful counting turtle steps on each side of the square. Many will draw rectangles.

Make sure they understand that a square has the same number of turtle steps on each side. After they draw what they think is a square, count the number of turtle steps on each side with them.

For example, here is the number of turtle steps on each side of a student's "square":

1, 2, 3, 4, 5...R R R...1 2 3 4...R R R...1 2 3 4 5...RRR...1 2 3 4.

Hmmm. Is that a square? (Many will still say it is.) Is 5 the same as 4?

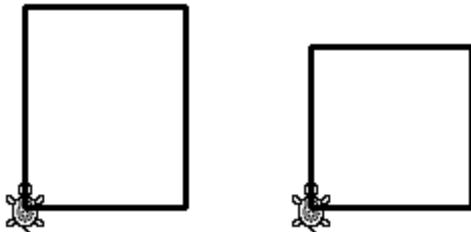

Have them start again and make a true square, with the same number of steps on each side. Many will notice a pattern in the commands.

1, 2, 3, 4...R R R...1 2 3 4...R R R...1 2 3 4...RRR...1 2 3 4

Now, can they draw a larger square? What is the tiniest square they can draw? Can they draw a square going to the left?

# 6 • Making Other Shapes

Now that the children can conquer the square, have them try other shapes.

You can draw a picture of each shape they make on a file card with their name on it to take home.

What pattern makes a triangle?

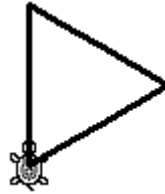

A circle?

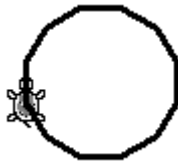

A rectangle?

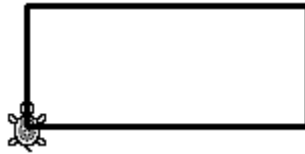

They might learn some new shapes, such as a

a parallelogram

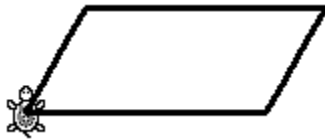

or a diamond



a hexagon



or a trapezoid.



# 7 • Kinderlogo Alphabet

Now the children are ready to make an alphabet. Ask them to draw a letter. The rule might be that the letter has to fit inside the screen, to avoid lines that wrap around. You will probably get a lot of letter T's and L's at the beginning.

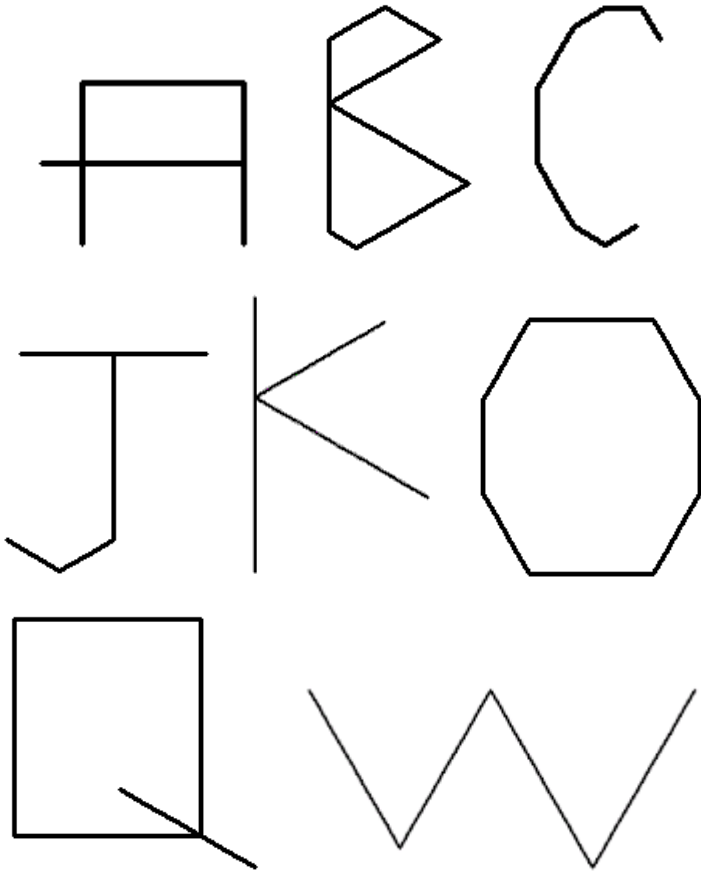

This project usually takes more than one session at the computer. On the second day, tell the children which letters you need to finish the whole alphabet. They will eventually make all the letters. You'll want to hang their work on the wall!

## 8 • Make a Star

The children love to draw all kinds of shapes. Here are some stars!

If they aren't sure how to start, give them a piece of paper and pencil and show them how to draw one. Then they can attempt a star with the turtle.

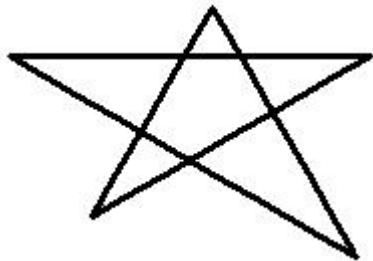
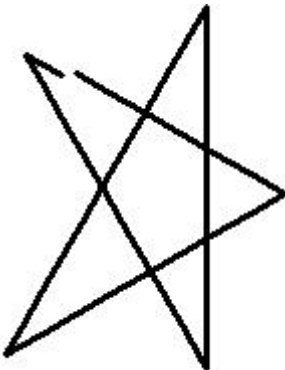
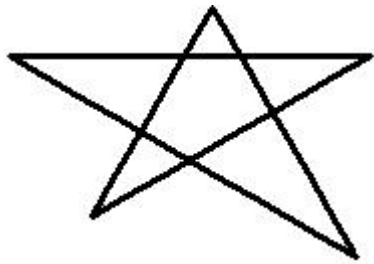
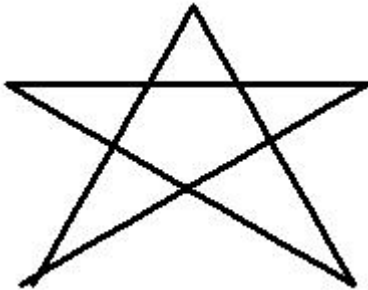
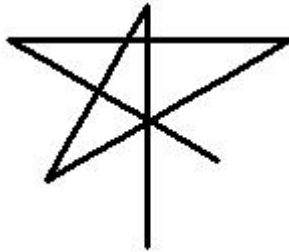

# 9 • Square Corner Day

Challenge your students to draw a picture using only square corners. Talk about what a square corner is: it needs to have 3 turns, either to the right or to the left.

Count with them – 1, 2, 3 – as you draw a sample square corner picture. Then see what they come up with!

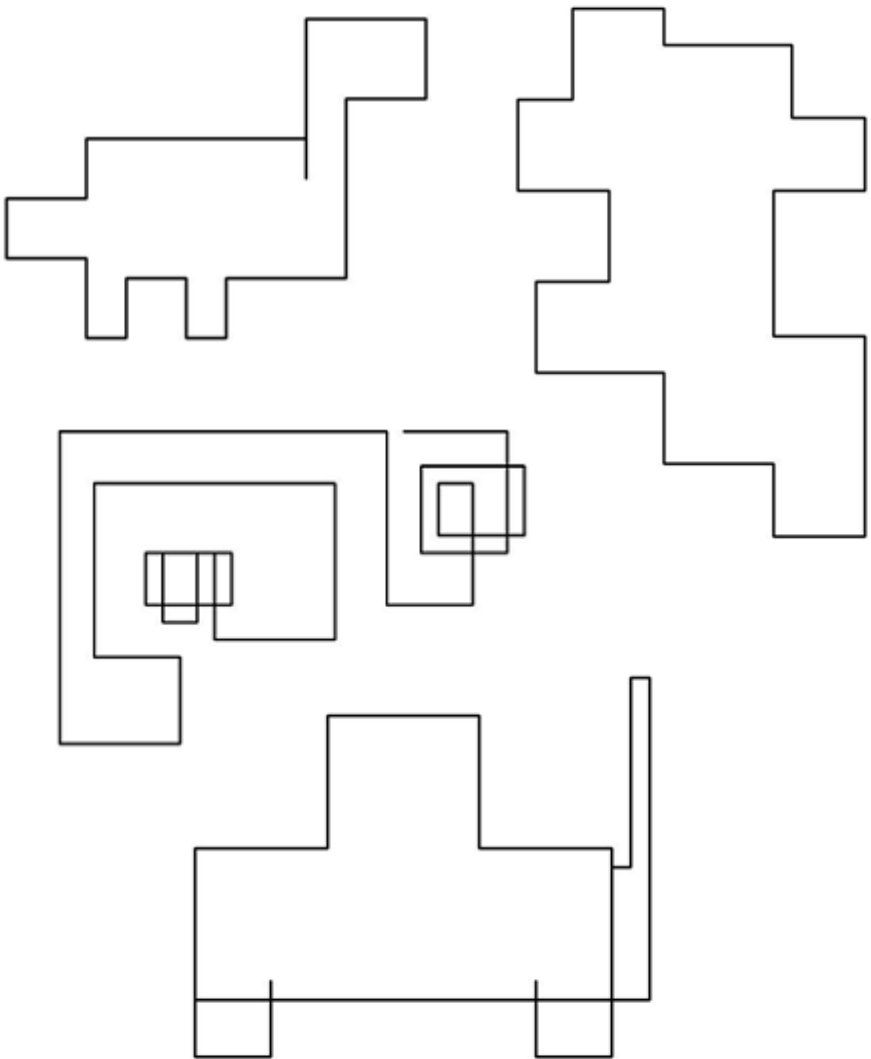

# 10 • Turtle Dance

Using **Turtle Dance**, your children can draw in different colors with 5 turtles that move and turn together. They will often call it the “Rainbow” activity.

They can press **D** to have the turtles repeat their dance. (This works the same as the **X** command, but doesn’t erase the last line.)

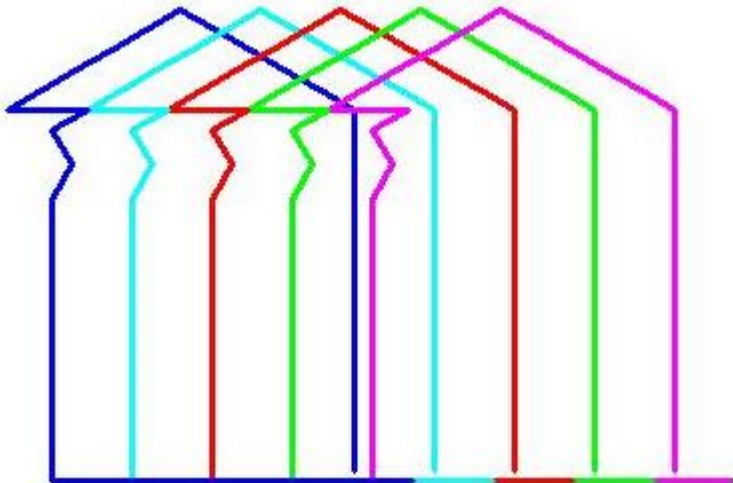
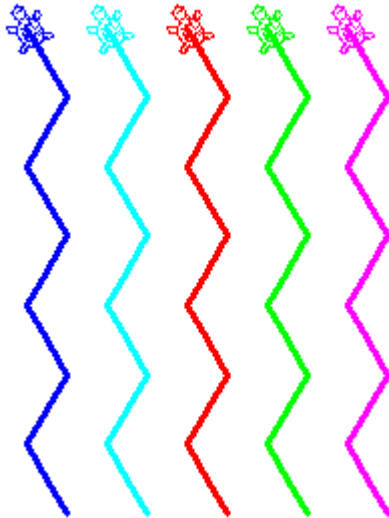

# 11 • Build a House

Challenge your students to draw a house using **Explore Level 1** commands. (Later they can build a more complicated house at higher levels.)

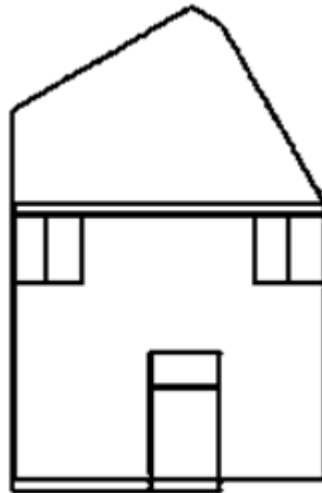
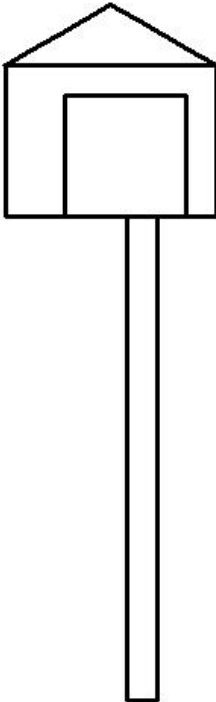
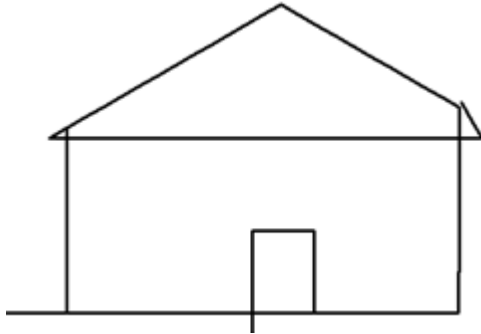

A cute bird house!

# 12 • Color Grid: Explore

Even though **Color Grid** is a **Level 4** activity, it can be used much earlier. It is included in the **Kinderlogo Extras** activities. It doesn't use standard turtle letter commands. Instead, children press a number to choose color, then click in a grid to fill in a square. They love it!

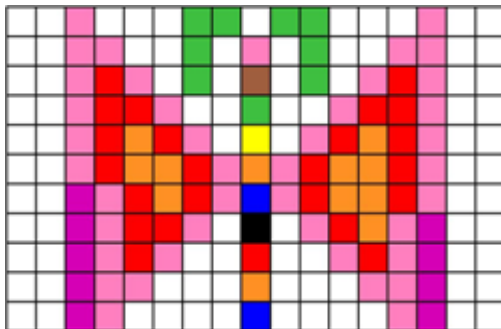
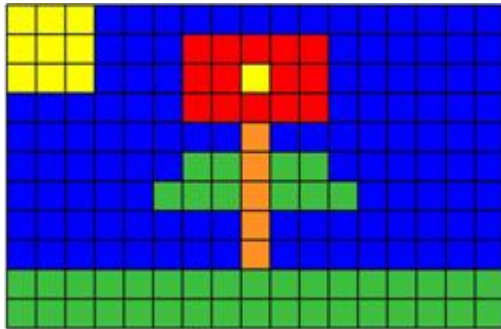



# 13 • Hearts!

Hearts are tricky because of the curves. Don't be alarmed if the hearts your students make are rather pointy! In many cases, they will not set out to draw a heart. A shape will occur that reminds them of a heart and then, there it is.

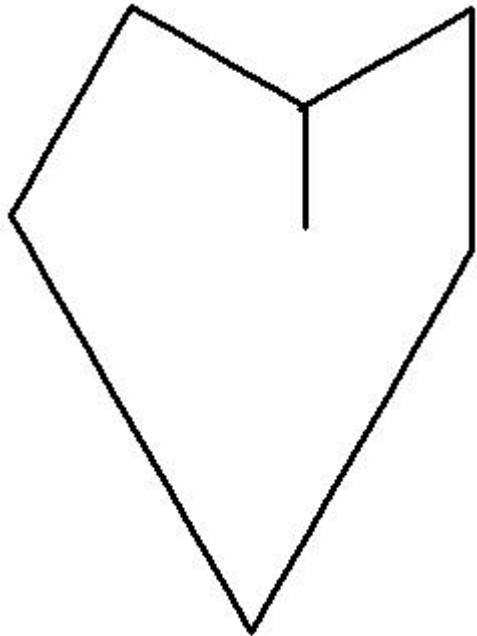
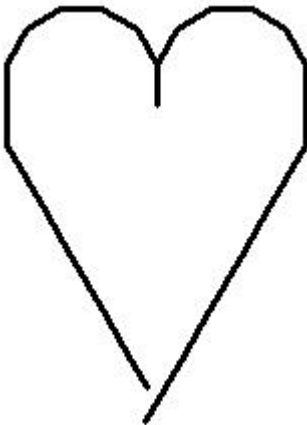
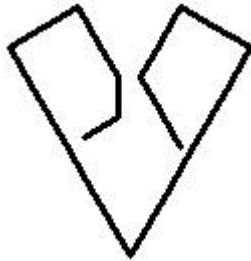
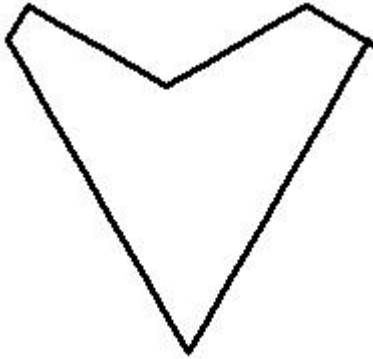

# 14 • Stairs

Challenge your children to draw a set of stairs. How tall can they make it? Can they figure out the pattern to make the steps? It's interesting to see that the stairs they draw all go in the same direction.

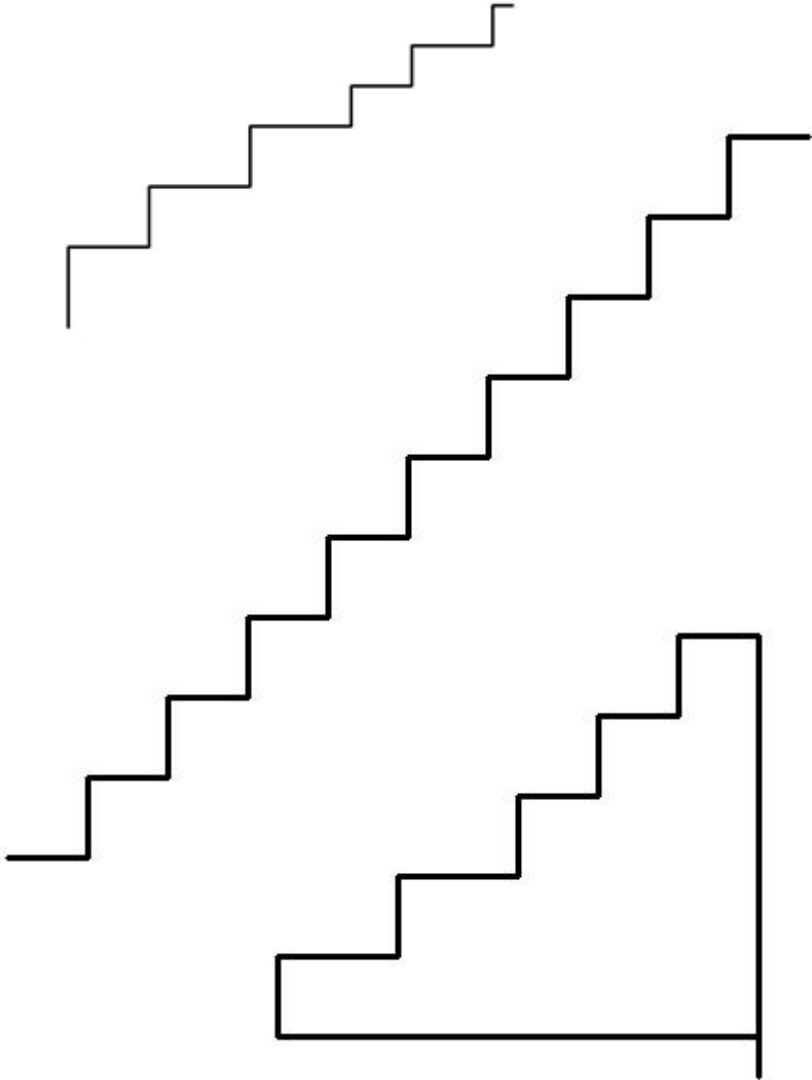

# 15 • Tower of Boxes

Challenge your children to draw a tower of boxes. How high will their tower be?

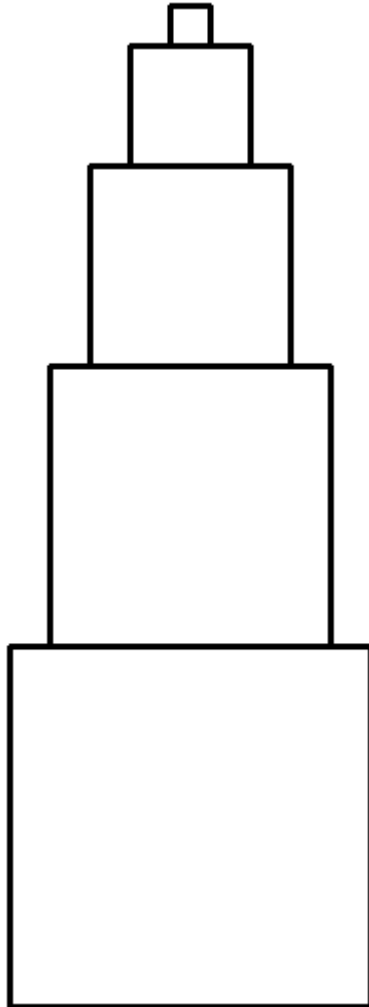

They have to plan carefully to make each larger box 2 extra turtle steps on each side to line them up like this!

# 16 • Spirals

Challenge your children to create a spiral.

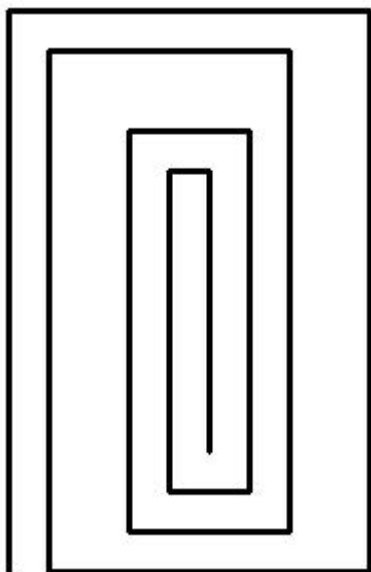
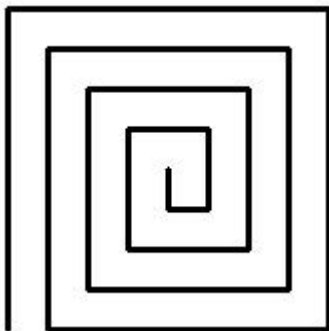
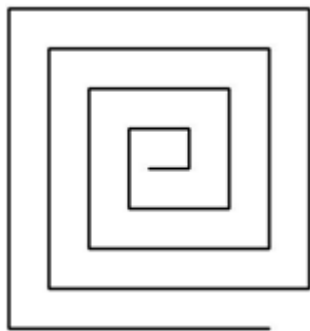

# 17 • Perimeters

Teach your students what a perimeter is. In the case of the turtle, it is the number of steps around the shape.

A square that is 4 steps on each side has a perimeter of 16.

Challenge your students to draw a shape with these perimeters.

Draw a square with a perimeter of 20.

Draw a hexagon with a perimeter of 18.

Draw a triangle with a perimeter of 3.

Draw a circle with a perimeter of 24.

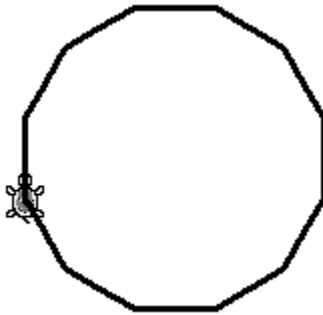

You don't normally think of a circle as having a perimeter, or a number of steps around it, but in Kinderlogo, that's how the turtle draws a circle. (It is actually a dodecagon, a term that you can share with your students, if you like.)

# 18 • Stencil Letters

Some children will love drawing letters. For an additional challenge, have them draw outlines of letters, or stencils. Here are some examples.

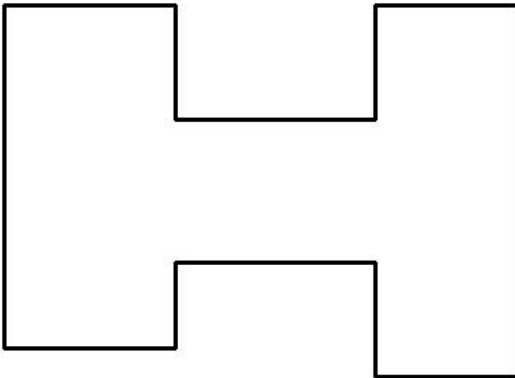
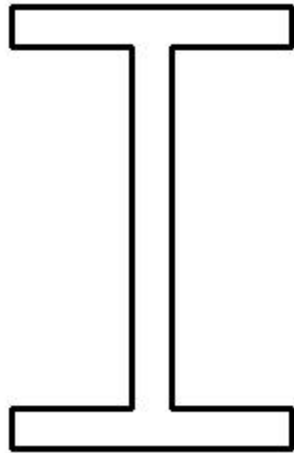
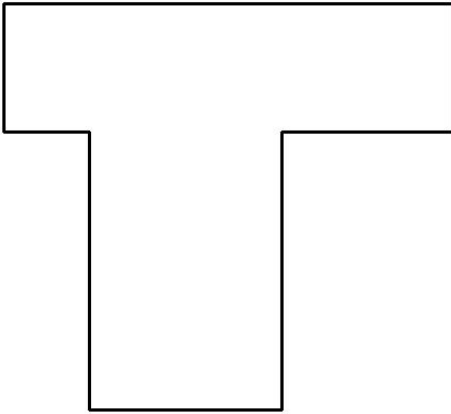

# 19 • Snaky Curves

What kind of design would a snake draw when it moves? Rather curvy, probably. Can your students create some curvy, snake-like designs?

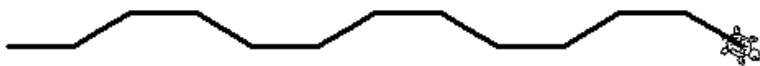
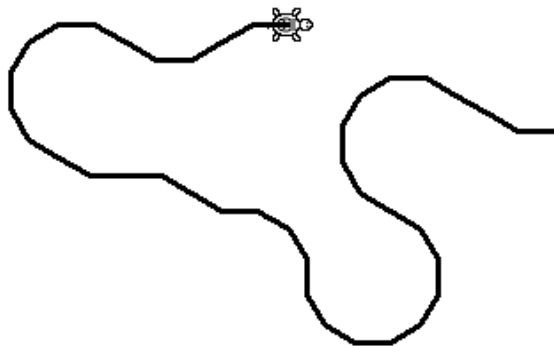
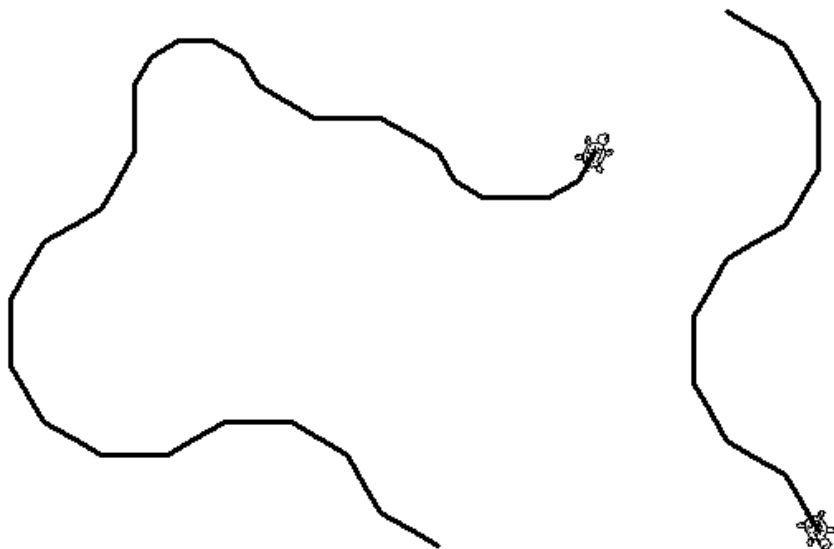

# Level 2

Now that the children have figured out how to draw squares and circles with the turtle, the Level 2 commands offer quick letter commands for these shapes. They will draw some amazing patterns with them, as you will see.

Now the turtle can also move backward and turn the opposite way, a handy shortcut.

Here are the new commands at Level 2:

- |          |          |   |
|----------|----------|---|
| <b>B</b> | Back     | Move the turtle backward 10 steps.        |
| <b>O</b> | Opposite | Turn the turtle the opposite way.         |
| <b>S</b> | Square   | Draw a square that is 40 steps on a side. |
| <b>C</b> | Circle   | Draw a small circle.                      |

Start with the **Exploring Level 2** activity so that students can try out the new commands.



# 20 • Patterns with Squares

Here are some patterns that children can draw using squares. Can they match the lists of commands to the pictures?

**S R S R ...**

**S F F F S F F F ...**

**S F S F ...**

**S R R S R R ...**

**S R R R S R R R ...**

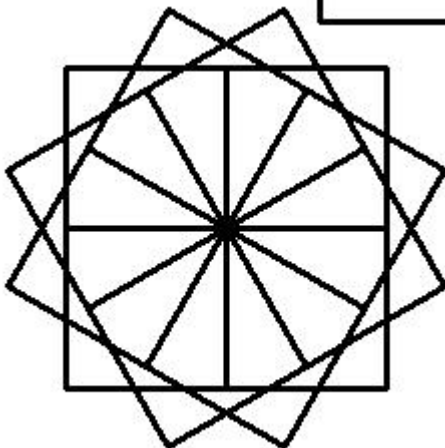
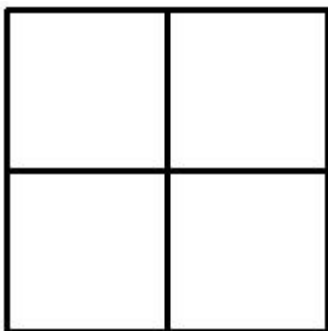
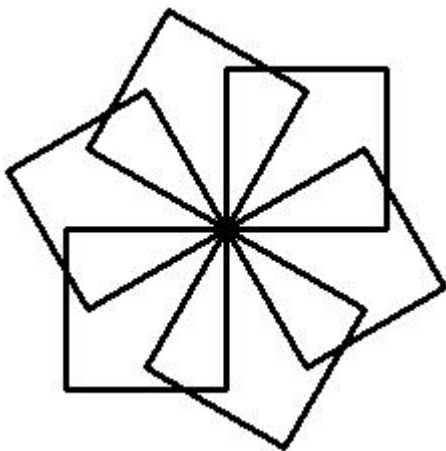

# 21 • Make a Vehicle

What can your students do with these square and circle commands? Challenge them to draw a vehicle! First talk about which vehicles have wheels and which don't. You'll be amazed at what they will come up with!

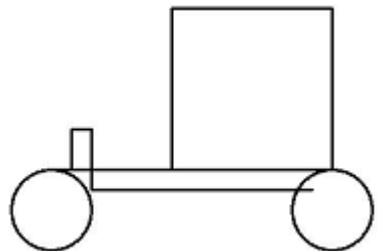
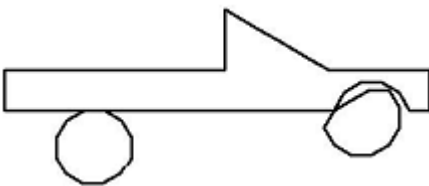
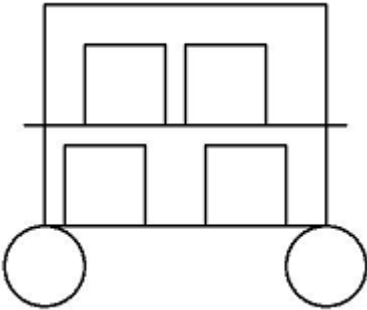
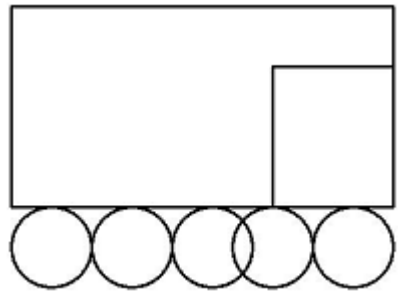
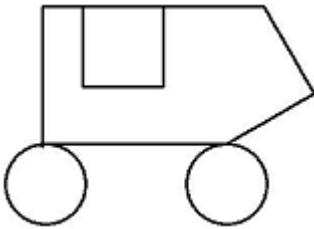
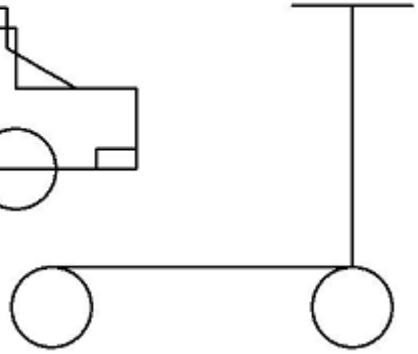
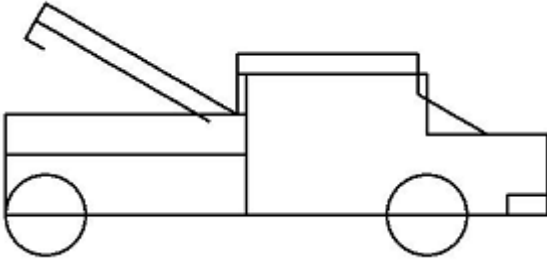

## 22 • Patterns with Circles

Here are some patterns that children can draw using circles. Can they match the lists of commands to the pictures?

CRCR...

CFFCFF...

CFCF...

CRRRCRR...

CRRRCRRR...

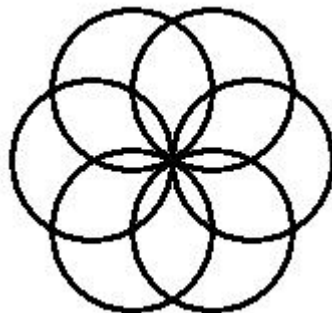
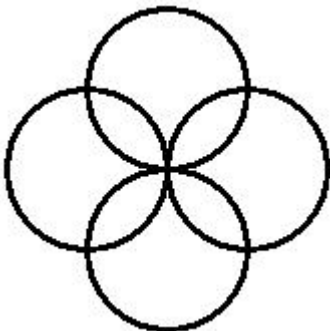
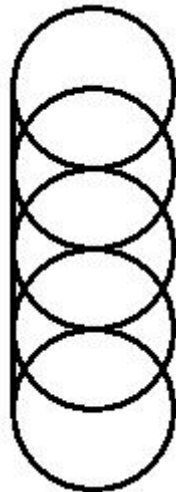
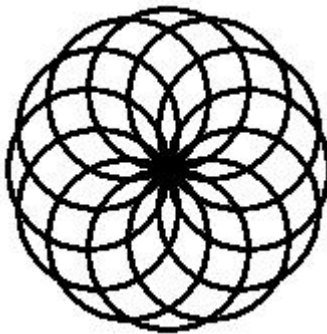
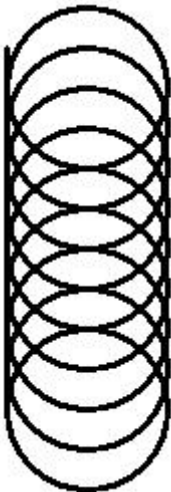

## 23 • Backward Maze

In **Backmaze**, the turtle can only move backward. The **F** key doesn't work! The children will have to figure out which way to turn to move the turtle backward through the maze. A tune plays when they get to the left edge of the screen.

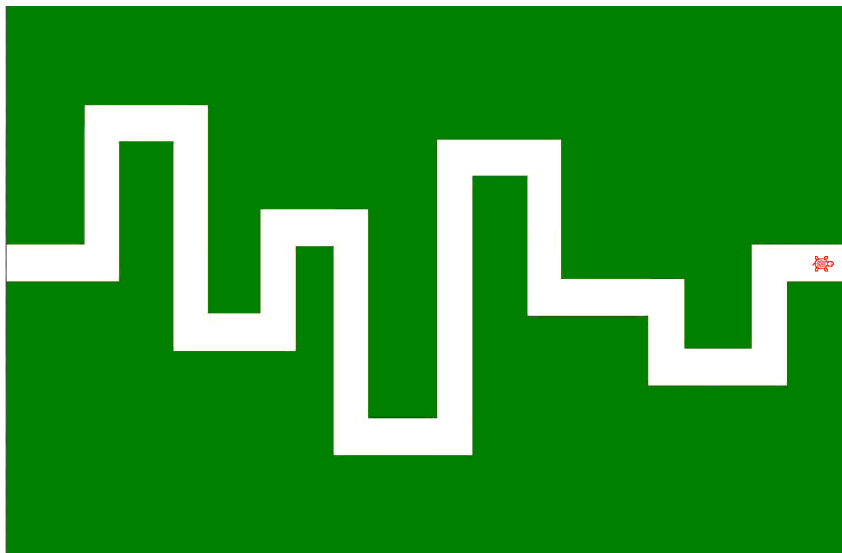

## 24 • Color Grid: Holidays

As you saw in Activity 12, **Color Grid** is a fun activity for children of all ages. This time, challenge them to create a picture with a holiday theme.

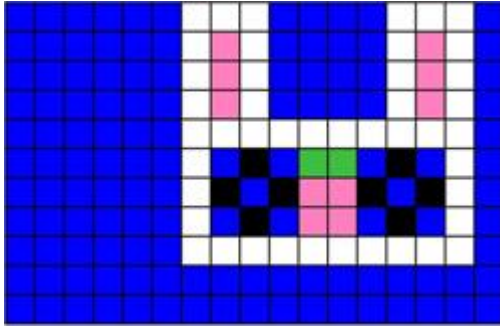

An Easter Rabbit

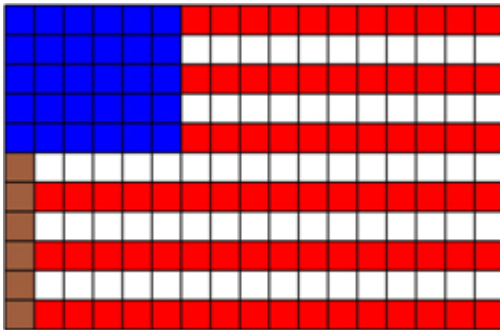

Veterans Day or Memorial Day

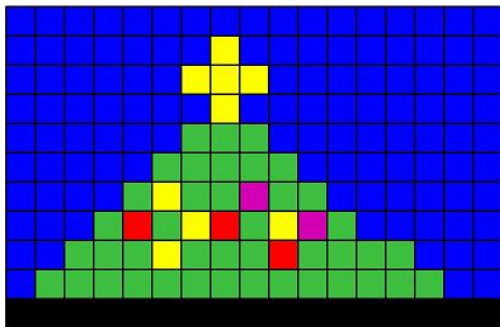

Christmas Magic

## 25 • Stick Figures

Your children can have fun drawing stick figures.

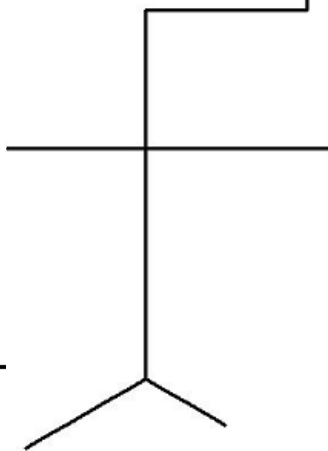
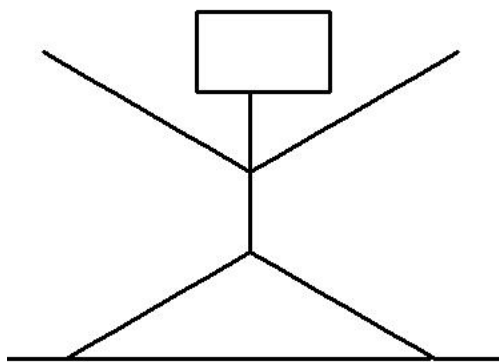
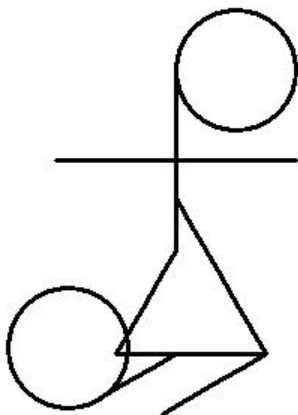
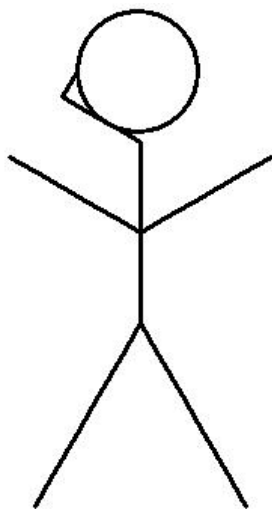
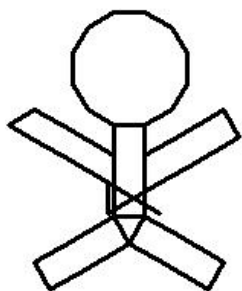

# 26 • Flower Patterns

Turn those patterns that use squares and circles into flowers!

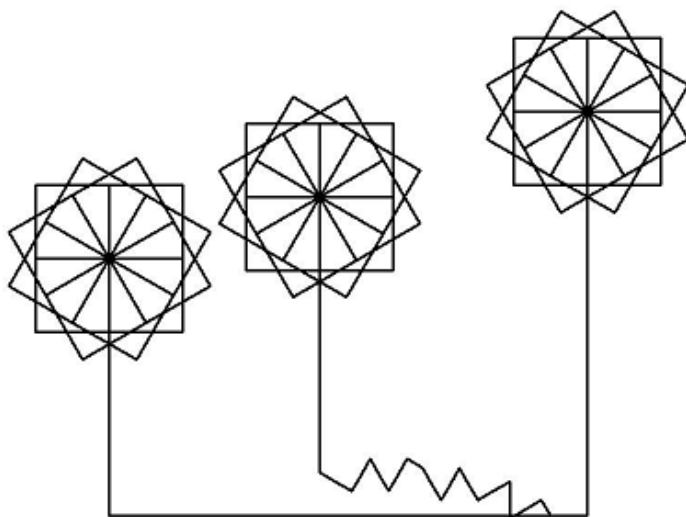
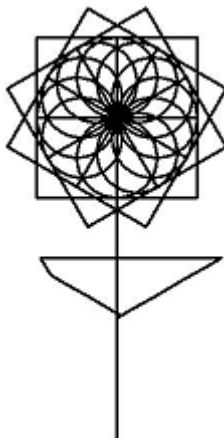
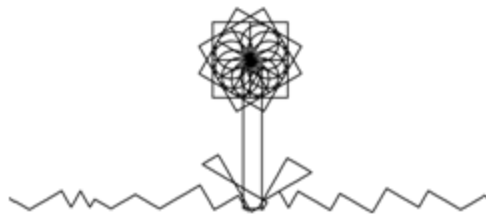

## 27 • Five Squares

In how many ways can you draw five squares that connect at one or more points or sides? Here are some examples.

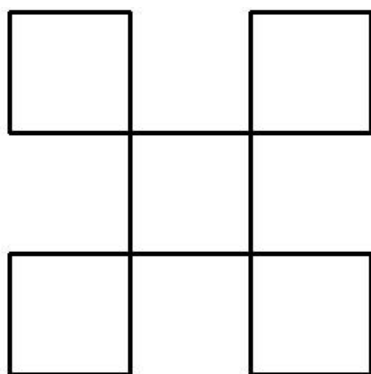
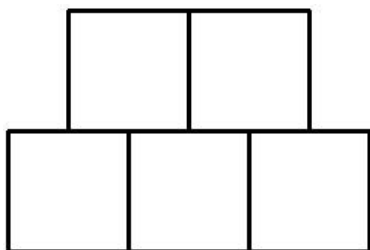
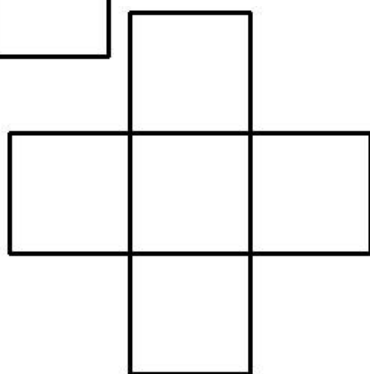
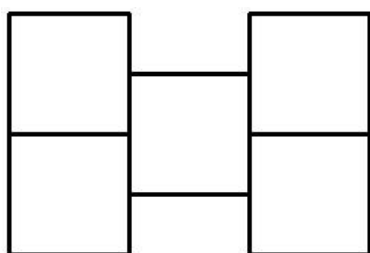
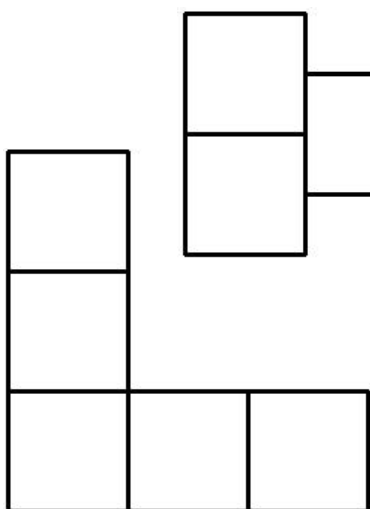



# 28 • Beads

In the **Beads** activity, students Copy, Finish, and Create patterns using virtual beads. They can type **S** for a square, **C** for a circle, and **T** for a triangle. After the pattern of 12 beads is complete, a tune plays, with a different tone for each shape bead. Thus they can both hear and see the patterns they make.

## Copy a Pattern

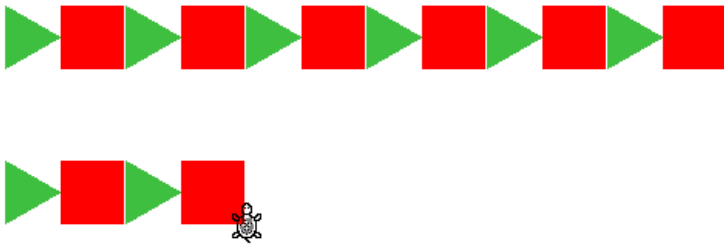

The student would type: **TSTSTSTSTSTS** to make this pattern.

## Finish a Pattern



The student would type: **TCTCTCTCTCT** to finish this pattern.

## Create a Pattern

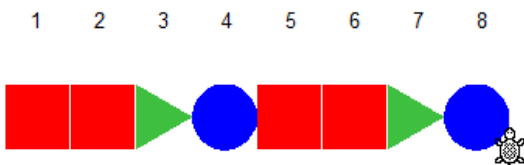

The student would type: **SSTCSSTCSSTC** to create this pattern.

## 29 • Half and Half

Can students make a design and then cut it in half? The shape or design will be symmetrical, either side-to-side or top-to-bottom.

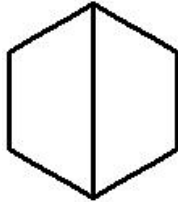
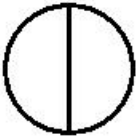

Or, how many ways can they find to color in approximately half the squares in **Color Grid** (at Level 4 or Kinderlogo Extras)? There are 187 squares in all, so they can't color in exactly half of them! This is also a great off-line activity to do with crayons and graph paper.

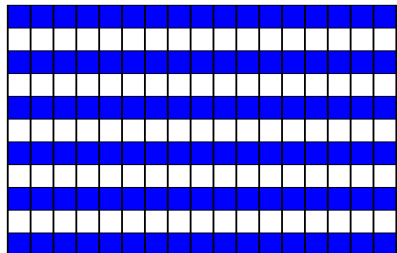
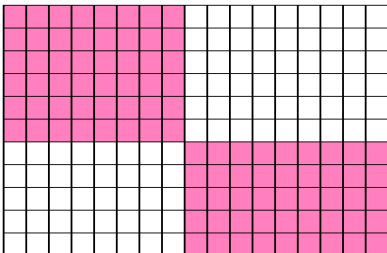
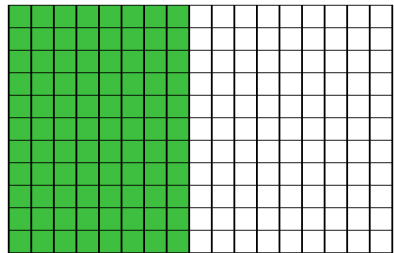
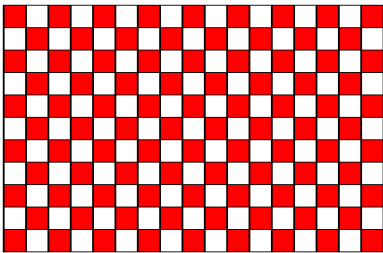

# 30 • Quarters

Next, the students can try dividing their shapes or designs into quarters. Now the shape or design is symmetrical in both directions. Here are some examples using **Exploring Level 2** and **Color Grid**.

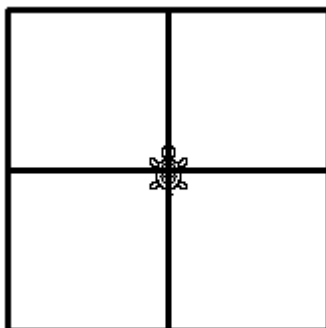
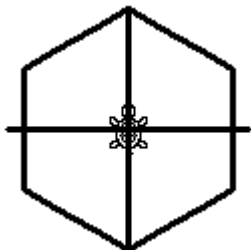

If there are 187 squares in all, how many would they fill in for a quarter of them?

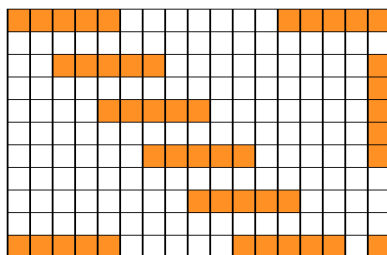
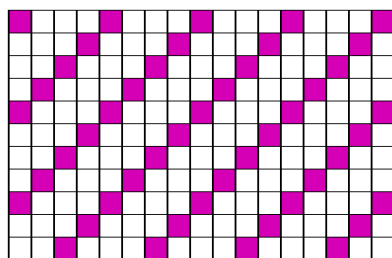
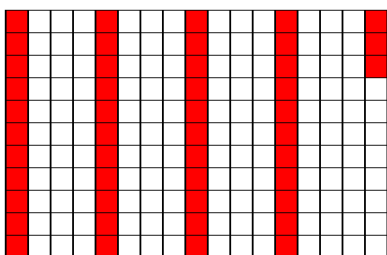

This activity is a great introduction to the **Symmetry** and **Mirror** activities, which they will meet in Level 4.

# 31 • A Village

Can your students make a village, or a building you would find in a village?

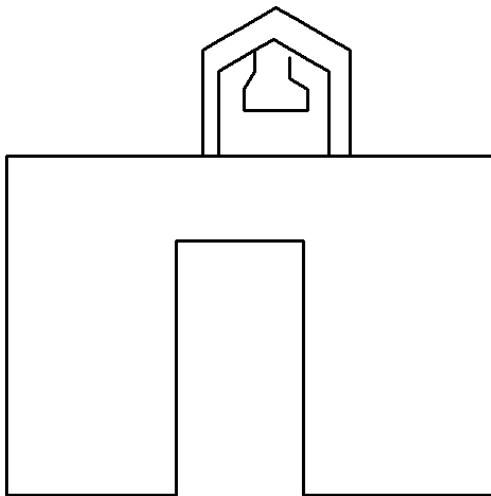
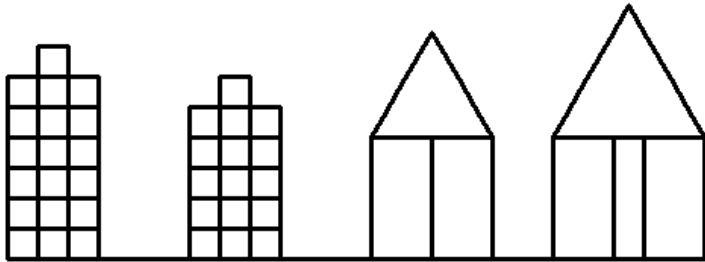
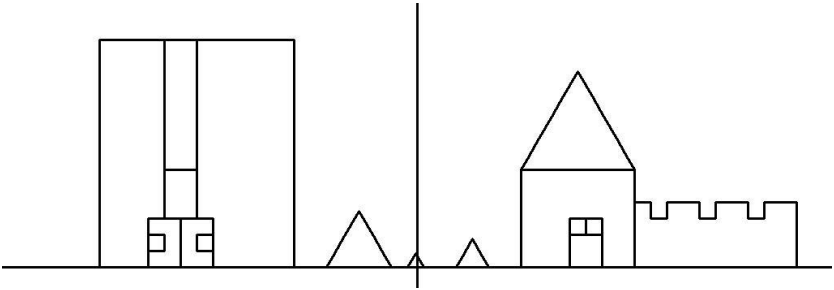

Every village needs a schoolhouse!

# 32 • Letter Dots

In **Letter Dots**, students connect the dots to form a letter, then type the letter they drew. Remind them that they can use **B** to back up and **O** to turn the turtle the opposite way.

Some letters are easy, such as this L.

1

1



3

2

3

what the student sees when she begins

finished letter

Other letters are more complex, such as this R.

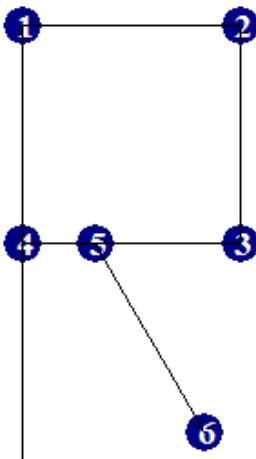

# Level 3

At Level 3, students can pick up the turtle's pen so that it can move without drawing a line. Then they can put the pen back down to continue drawing. This powerful pair of commands opens up all types of possibilities for amazing pictures!

They can also hide and show the turtle. This allows them to see their picture without the turtle, or to check if two lines meet the way they want. They can still draw with their invisible turtle!

The **H** command is a quick way to send the turtle back to its home in the center of the screen, point straight up.

Here are the new commands at Level 3.

|          |        |  |
|----------|--------|--|
| <b>U</b> | Up     | Picks up the turtle's pen so it cannot draw.               |
| <b>D</b> | Down   | Puts the turtle's pen back down so it can draw.            |
| <b>T</b> | Turtle | Hides or shows the turtle.                                 |
| <b>H</b> | Home   | Moves the turtle to its Home, in the middle of the screen. |

Start with the **Exploring Level 3** activity so that students can try out the new commands.

## 33 • Hello, My Name Is...

Now that the children can move the turtle without drawing a line, the turtle can draw their names! They have to plan ahead to make all the letters fit on the screen. For very long names, they can just draw their initials.

Alahi

Alex

Louis

Jetho

# 34 • Patterns Everywhere!

Children will always return to drawing their favorite patterns from Level 2. Now, at Level 3, they can put them in different parts of the screen!

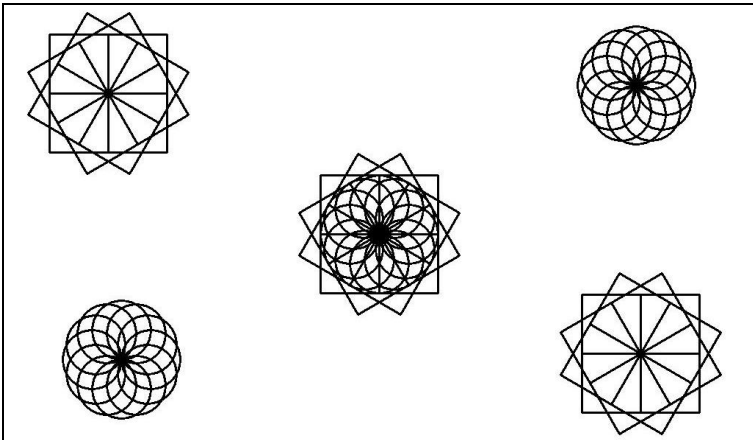
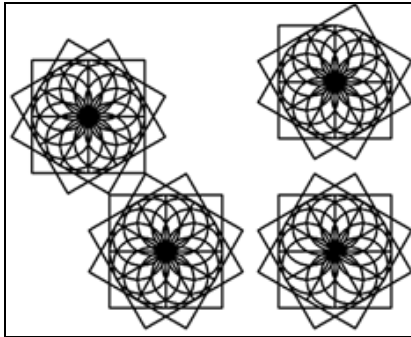
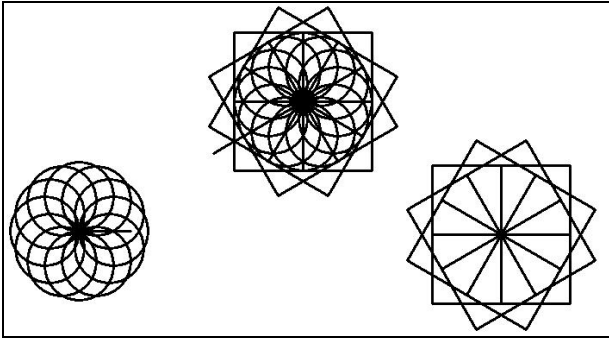



# 35 • Animals

Animals, a perennial favorite for children to draw, are a bit tricky in Kinderlogo. But here are some amazing examples!

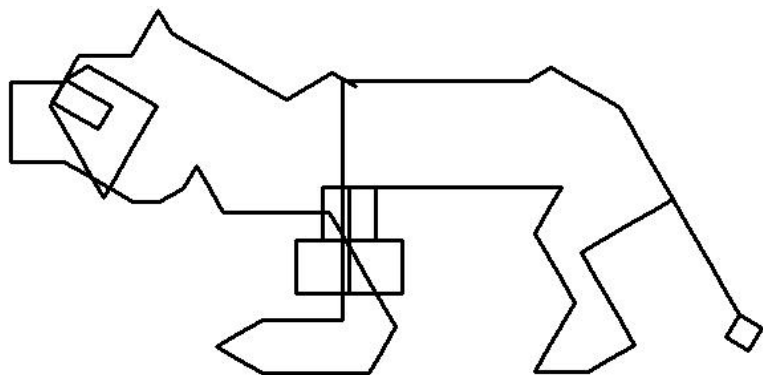
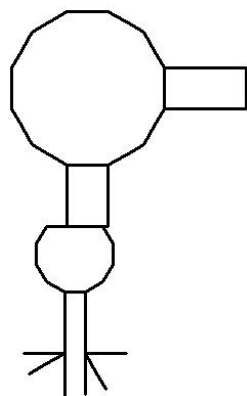
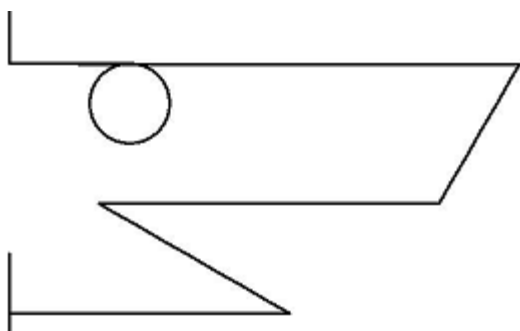
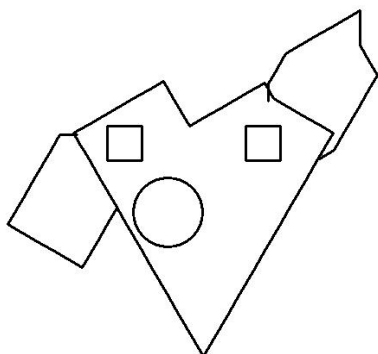
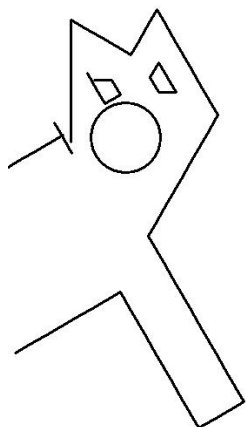

## 36 • Free Time

Give students free time to create whatever they want. Here are examples of some complex pictures they might come up with!

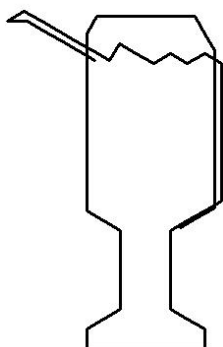
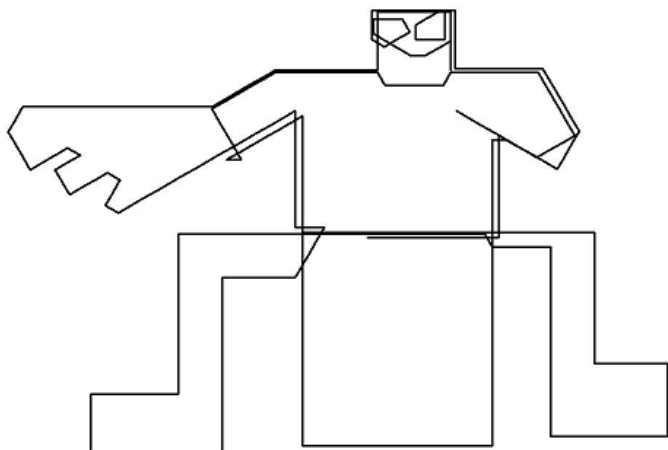
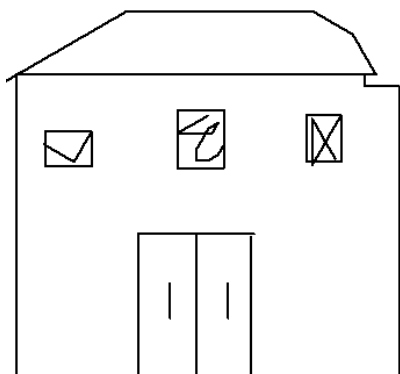

## 37 • Target Game

The **Target** game is similar to Balloon (at Level 1), except that in this Level 3 activity, the turtle is invisible! Can the students picture in their minds which way the turtle is pointing, and how much each **R** or **L** command will turn it? The turtle will point in a random direction at the start of each turn.

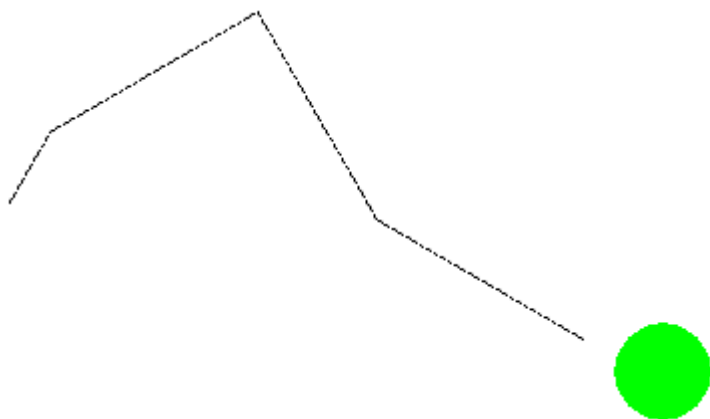
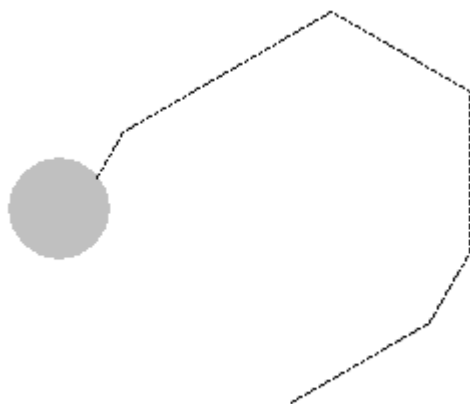

# 38 • Tic-Tac-Toe

Teach the children how to play Tic-Tac-Toe, if they don't already know. Then they will be ready to play the Kinderlogo version.

The **TicTacToe** game starts with a blank grid, with the turtle in the center.

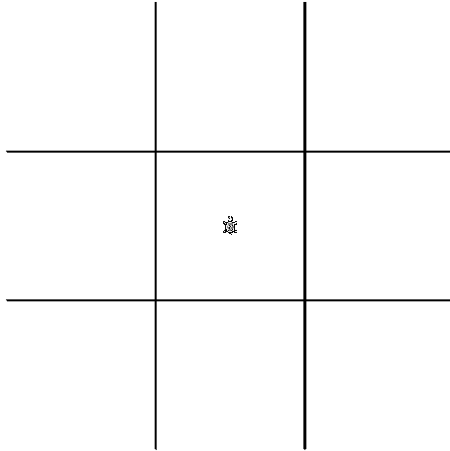

Children take turns marking the squares with a circle (O) or X (X). They will need to pick up the turtle's pen (U) before moving it, to avoid drawing a path to their destination. Then they need to remember to put the pen back down (D) to draw their mark.

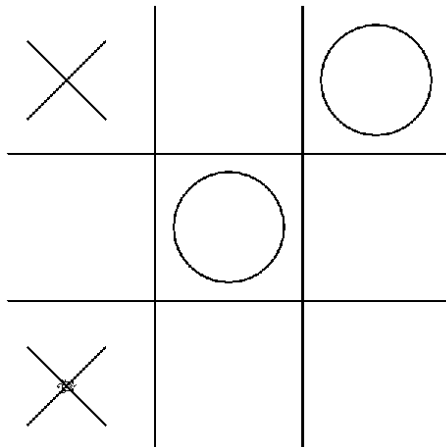

# Level 4

At Level 4, students can add color to their drawings. They can change the pen color and the background color. They can also fill in circle and square shapes automatically, and other shapes, if they perform a couple of additional steps.

If they have used **Color Grid**, then they will be familiar with the color numbers. Point out that the colors are in rainbow order.

Here are the new commands at Level 4.

## Pen Colors:

Type the number to change the color of the turtle's pen.

|                 |                 |                |
|-----------------|-----------------|----------------|
| <b>0</b> White  | <b>1</b> Black  | <b>2</b> Red   |
| <b>3</b> Orange | <b>4</b> Yellow | <b>5</b> Green |
| <b>6</b> Blue   | <b>7</b> Purple | <b>8</b> Pink  |
| <b>9</b> Brown  |                 |                |

**I** Ink on Starts filling squares (**S**) and circles (**C**).  
(**I** is the first letter of Ink.)

**K** Ink off Stops filling squares (**S**) and circles (**C**).  
(**K** is the last letter of Ink.)

**P** Paint Fills in the background of the area around the turtle.

Use the **P** command to fill in the background of the entire window when you first start **Exploring Level 4**. To paint in the inside of an existing shape, pick up the turtle's pen (**U**), move the turtle to the inside of the shape, put the pen down, type a number to set the pen color, then press **P** to fill the shape with color.

Start with the **Exploring Level 4** activity so that students can try out the new commands.

## 39 • Colored Lines

Have fun changing the color of the turtle's pen and drawing lines.

Students will love recreating their favorite Level 2 patterns, this time in color.

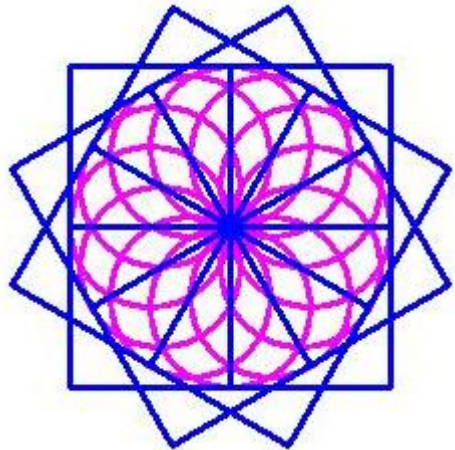
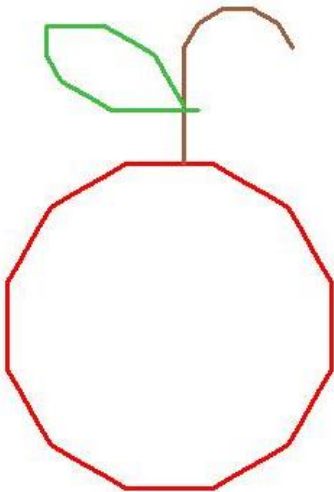
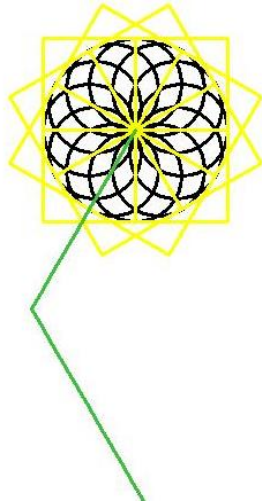
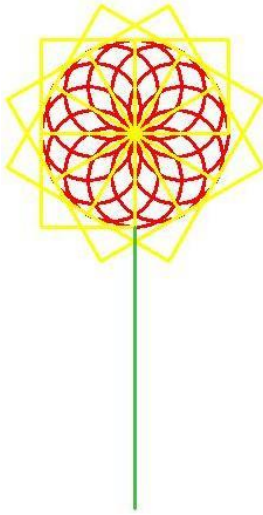

# 40 • Colored Shapes

Have students try the **I** and **K** commands to fill in circles (**C**) and squares (**S**) automatically. **I** turns “ink” on and **K** turns it off. They can also manually fill in other shapes.

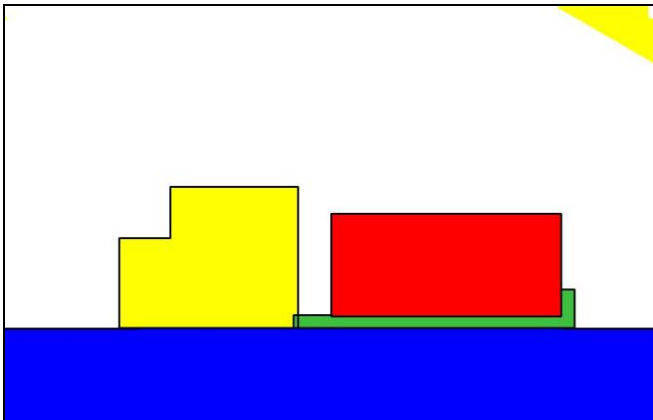
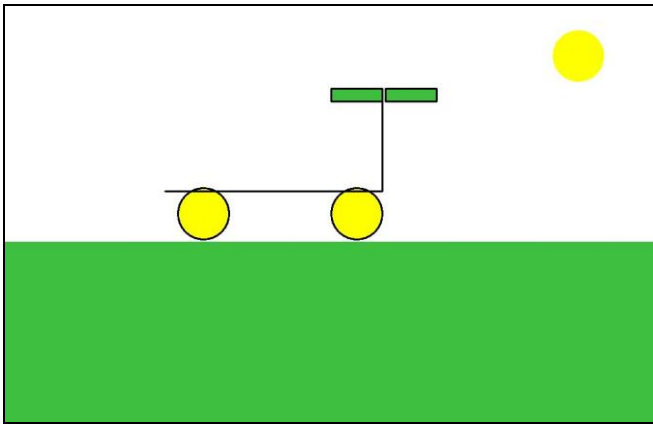
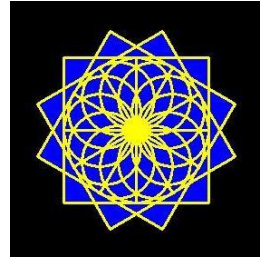
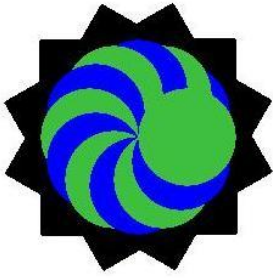

# 41 • Multiplication & Area

“My students aren’t ready for multiplication or area,” I hear you say. They may not be in your grade’s curriculum, but here is a fun way to sneak in some of these concepts.

Hold up a 3x5 index card. Tell the students it is called a 3x5 index card. Have them figure out why it is named that. (On the blank back of the card, draw in 1 inch squares. If they need help, show them that.) Do the same with a 4x6 index card.

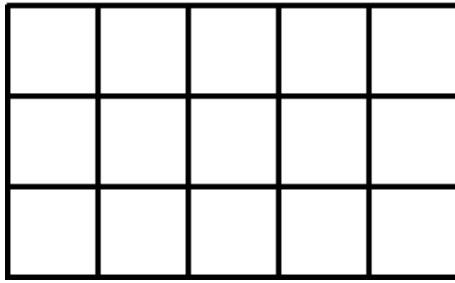

Then ask them how many squares in a 3x5 index card. 15! How about the 4x6 index card? 24!

Create a word processing or spreadsheet document with places to record all the different combinations from 1 x 1 to 10 x 10.

|        |  |        |  |        |  |        |  |
|--------|--|--------|--|--------|--|--------|--|
| 1 x 1  |  | 2 x 1  |  | 3 x 1  |  | 4 x 1  |  |
| 1 x 2  |  | 2 x 2  |  | 3 x 2  |  | 4 x 2  |  |
| 1 x 3  |  | 2 x 3  |  | 3 x 3  |  | 4 x 3  |  |
| 1 x 4  |  | 2 x 4  |  | 3 x 4  |  | 4 x 4  |  |
| 1 x 5  |  | 2 x 5  |  | 3 x 5  |  | 4 x 5  |  |
| 1 x 6  |  | 2 x 6  |  | 3 x 6  |  | 4 x 6  |  |
| 1 x 7  |  | 2 x 7  |  | 3 x 7  |  | 4 x 7  |  |
| 1 x 8  |  | 2 x 8  |  | 3 x 8  |  | 4 x 8  |  |
| 1 x 9  |  | 2 x 9  |  | 3 x 9  |  | 4 x 9  |  |
| 1 x 10 |  | 2 x 10 |  | 3 x 10 |  | 4 x 10 |  |

Have the students start the **Color Grid** activity. Challenge them to color in a rectangle with color, then tell you what the dimensions are and how many squares are colored in. Fill in your chart with the number. See how many they can figure out!



# 42 • Flags of the World

Here is a fun activity that combines geography and art.

First have the students open a web browser and type: flags images

They can then click the link named 'Images for flags'. Or go here: [en.wikipedia.org/wiki/List\\_of\\_aspect\\_ratios\\_of\\_national\\_flags](http://en.wikipedia.org/wiki/List_of_aspect_ratios_of_national_flags)

Have them look for a flag that they could draw in Kinderlogo, using either **Exploring Level 4** or **Color Grid**.

Here are some flags they might want to try to recreate:



Ethiopia



Antarctica



Sweden

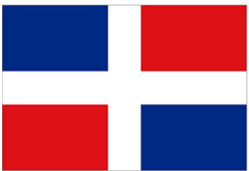

Dominican Republic



Gabon

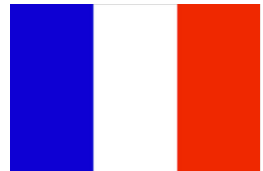

France

Some will want to draw the US flag.

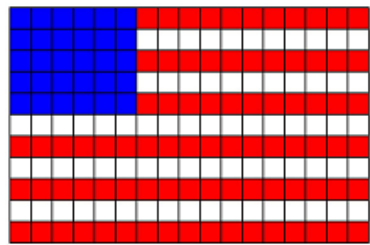
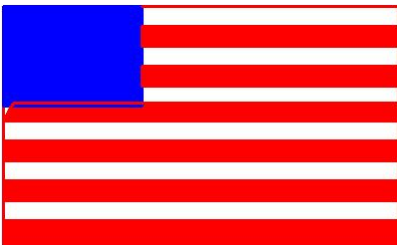

Finally, have them search the web for a map that shows where their country is. They can type, for example, 'map Gabon'.

# 43 • Mirror

The Level 4 **Mirror** activity allows students to explore lines of symmetry. This activity starts with two turtles. The turtles move together in the same direction when you give an **F** or **B** command. However, when you type **R** or **L**, they turn in opposite directions. All the color commands are available, so students can make colorful and symmetrical designs.

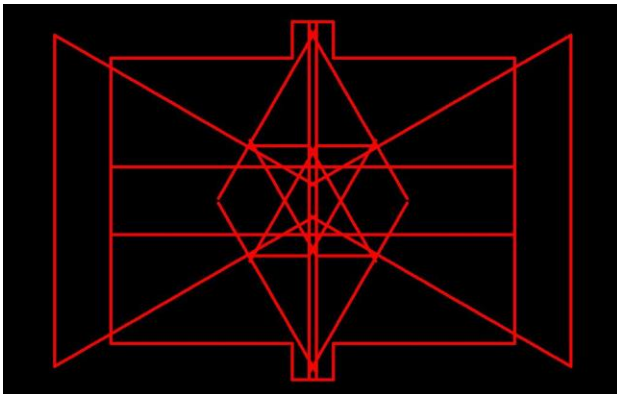
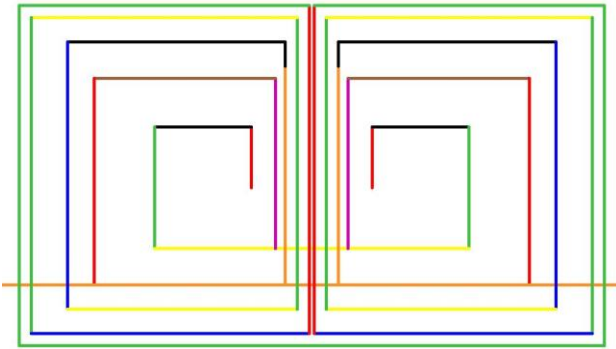
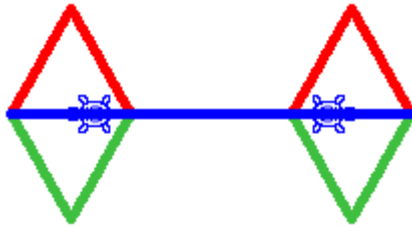

## 44 • Turtle Time

Can the turtle tell time? Well, not really, but you can draw clock hands to show times.

Start by choosing an hour. Don't forget to make the hour hand short and the minute hand long. Can you tell what time this is?

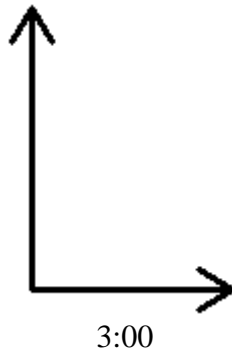

Next, try a more complicated time. Explain that it is impossible to draw a half-hour accurately, because the turtle can't turn a  $45^\circ$  angle.

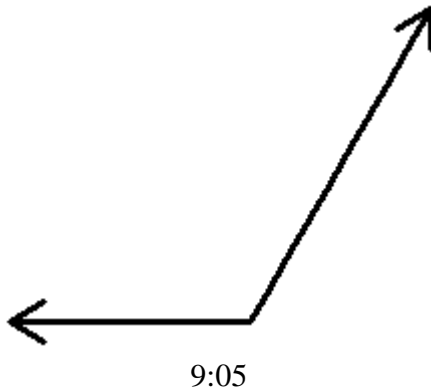

Remind students that the **H** command quickly and easily returns the turtle to the center of the screen. (Pick up the pen first with **U**, or you will draw a line back Home! Don't forget to put the pen back down with **D**.) Hide the turtle with **T**, if you like.

# 45 • Color Grid: Graph Paper

Give students graph paper and colored pencils or crayons. Have them draw a black box around a rectangle of boxes that is 17 x 11, the same size as the **Color Grid** activity.

Have them draw a picture on the graph paper by filling in the boxes with color.

When they are done, they can start up the **Color Grid** activity and recreate the picture they drew on the graph paper.

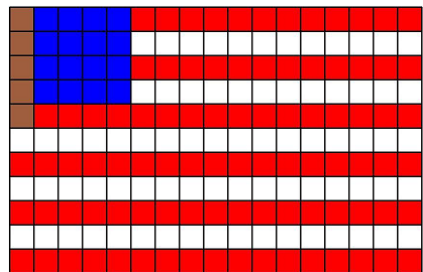
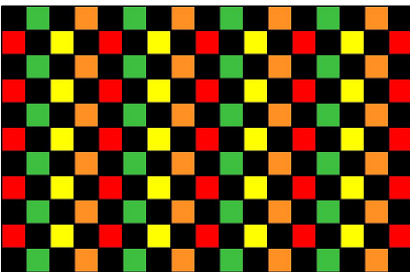
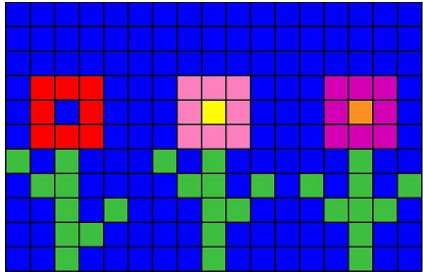
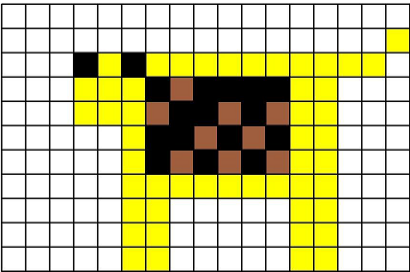
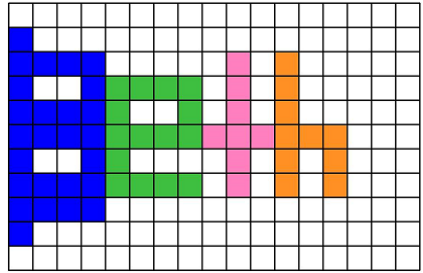
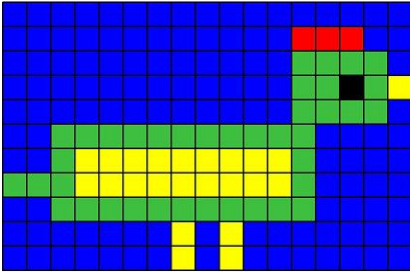

# 46 • Lollipops!

How many colorful lollipops can your students draw?

They can use the **I** command to fill in circles automatically.

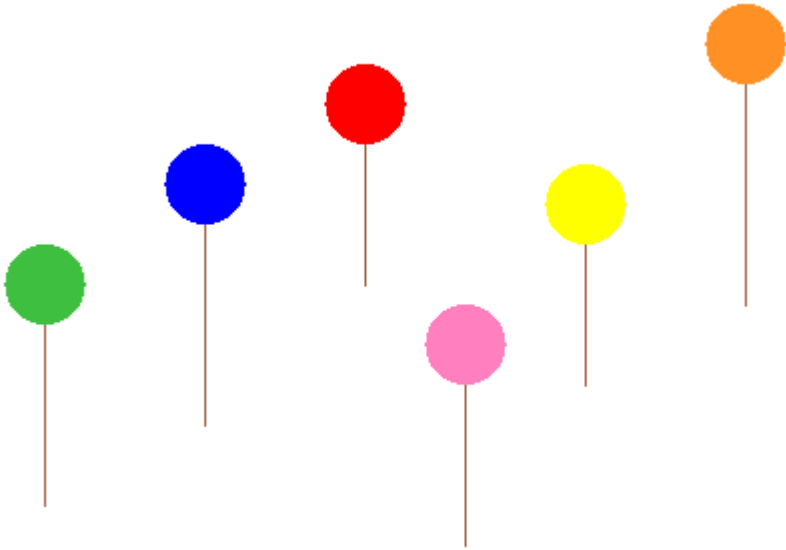

Have them explain their picture. What color did they use for the lollipop stick, and why?

What flavor is each lollipop?

Which one is their favorite?

Can they figure out how to make a black border around their lollipop?

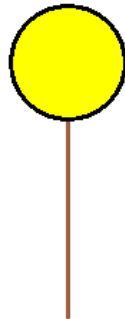

# 47 • Symmetry

The Level 4 **Symmetry** activity allows students to explore with 2 lines of symmetry. This activity starts with four turtles. The turtles move together in the same direction when you give an **F** or **B** command. However, when you type **R** or **L**, they turn in opposite directions. All the color commands are available, so students can make colorful and symmetrical designs.

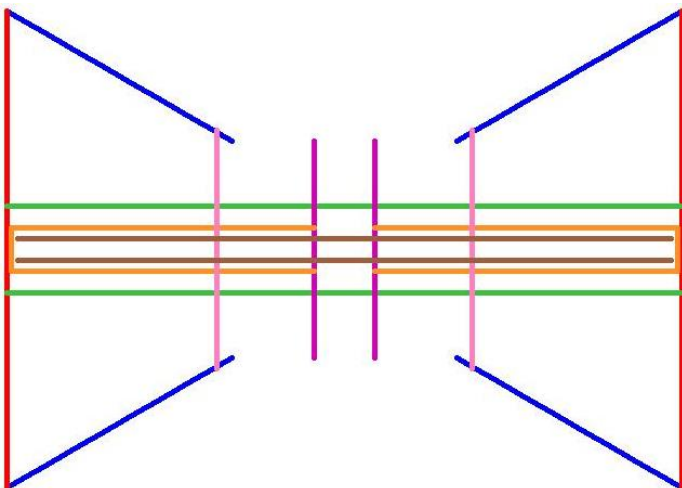
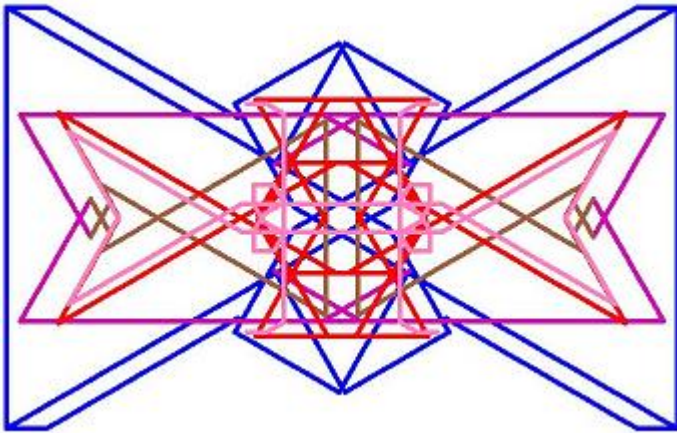

# Level 5

At Level 5, students utilize the real power of Kinderlogo, and of programming. They can draw a design with the turtle, store it by name, then redraw it whenever they want by entering that name.

The names they can use are single letters: **A**, **G**, **M**, and **Z**. They can think of the acronym **GAMZ** to help them remember the letters they can use. Or they can press the **?** key to see a list of the commands.

All the commands from previous levels are also available.

Here are the new commands at Level 5.

**A, G, M, or Z**            Store a set of commands.

**E**                         Erase a set of commands stored by a letter.

# 48 • Sizes

Students can explore shapes in different sizes in the **Sizes** activity. Which shape will they choose? Can they orient the shape in different directions? What happens if they enter a size number that is very large—too large to fit within the limits of the screen size?

They can press any of four letters to draw a shape:

**C** – circle    **T** – triangle    **S** – square    **H** – hexagon

A dialog box opens where they can enter a number for the size of the shape.

What size square?

---

---

Here is C 50, C 60, C 70, C 80, C 90, C 100:

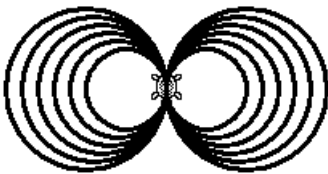

If they press **O** to turn the turtle the opposite way, they can create the same

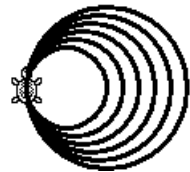

set of circles with this result.

Then turn the turtle to point to the right and to the left and repeat.

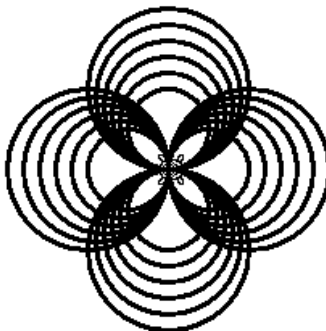



# 49 • Teach the Turtle

Using the **Exploring Level 5** activity, have students play with drawing a design, storing it with a letter name (**A**, **G**, **M**, or **Z**), then drawing it somewhere else on the screen.

You are likely to again see their favorite patterns from Level 2!

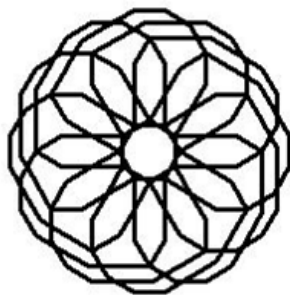
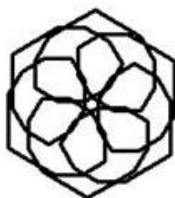
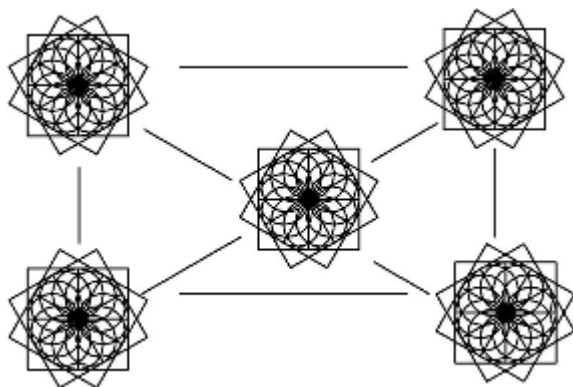

# 50 • Picture Pairs

Using **Exploring Level 5**, try to capture the initial design that the student drew and then named. You can make a wonderful display of “Picture Pairs.” Can your students match the initial design with the one where it is repeated multiple times? This can be quite tricky!

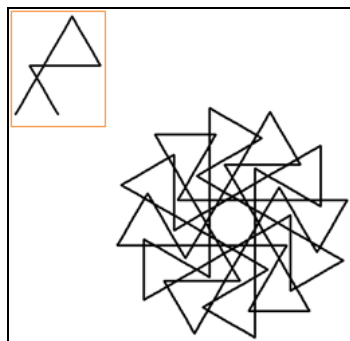
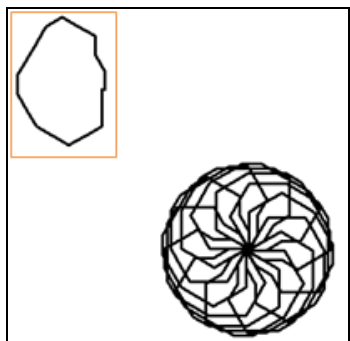
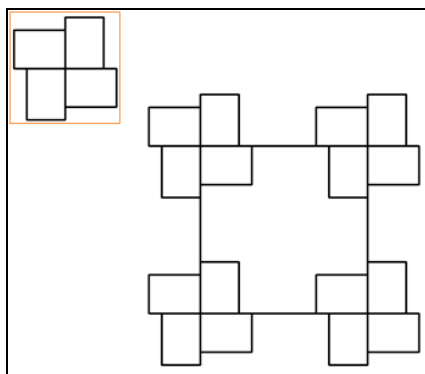
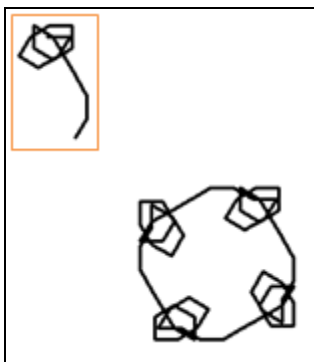
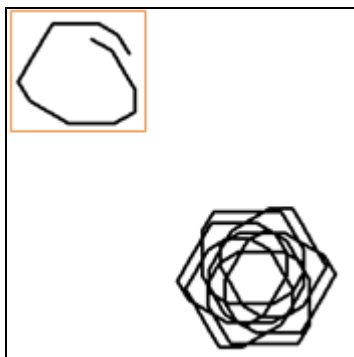
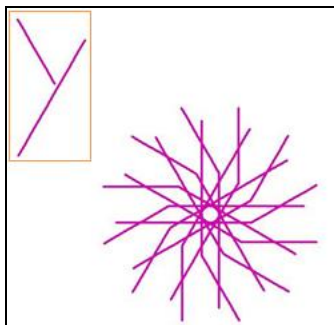

# 51 • Logic Game

In the **Guess** activity, students try to guess the shape that the computer is thinking of. They press letters to guess the size, color and shape.

The computer is thinking of a shape. Try to guess its color, size and shape!  
Type the first letter of each word to guess it.

Pick a size — Small, Medium, Large: S

Pick a color — Red, Yellow, Green, Blue, Purple: R

Pick a shape — Triangle, Square, Hexagon, Octagon, Circle: T

You guessed SMALL RED TRIANGLE

RIGHT Size WRONG Color RIGHT Shape

Press any key to guess again.

The turtle draws the shape that the student guessed, and displays any correct answers above it.

SMALL

TRIANGLE



Students use the clues to narrow down the possibilities.

After a couple more guesses, the correct color is guessed: purple.

Pick a size — Small, Medium, Large: S

Pick a color — Red, Yellow, Green, Blue, Purple: P

Pick a shape — Triangle, Square, Hexagon, Octagon, Circle: T

You guessed SMALL PURPLE TRIANGLE

RIGHT Size RIGHT Color RIGHT Shape

Great job! You guessed the computer's shape!

SMALL

PURPLE

TRIANGLE



It may take many guesses, especially before they learn how best to use the clues to their advantage.

# 52 • Snowflakes

Show your students these snowflake designs. Can they figure out which parts they could store with a letter name in the **Exploring Level 5** activity? Can they reproduce these snowflakes? Can they create their own snowflake designs?

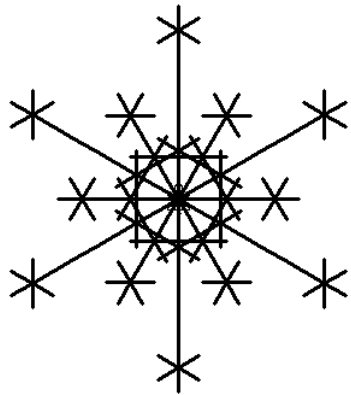
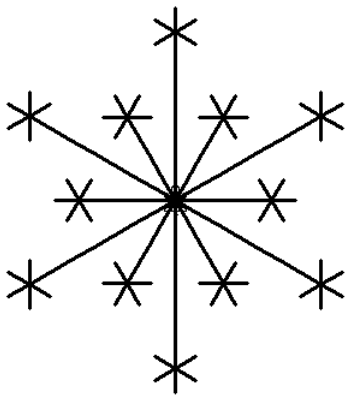
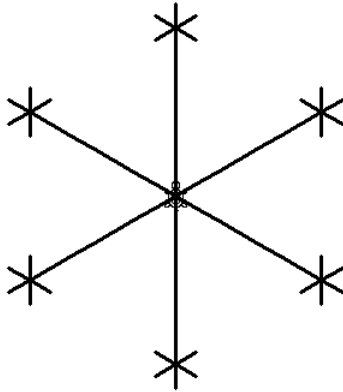

Erase a letter that stores a design by pressing **E**. Then type the letter to erase that set of commands.

When you press **N** to start something new, you can choose to erase just the **Picture** (keeping your letter designs), **All** (picture and letter designs) or cancel with **No**.

# Student Pages

Give the following set of pages to your students, if you like.

# Level 1 Commands

Here are the Level 1 commands.

- F** Forward    Move the turtle straight ahead.
- R** Right      Turn the turtle to the right.
- L** Left        Turn the turtle to the left.
- X** Erase       Erase your last command.
- N** New         Start a new picture (click Yes).

# 1 • Meet the Turtle

Let's play with the turtle! 

Can you make it walk? Press **F**.

Can you make it turn? Press **R** or **L**.

Have fun!

## 2 • Exploring with the Turtle

What can you draw with the turtle?

Draw anything you want!

Give a name to your picture!



## 3 • Balloon Game

Can you get the turtle to the balloon?

Did you hear the balloon pop?

What happens to the balloon after you play for a while?

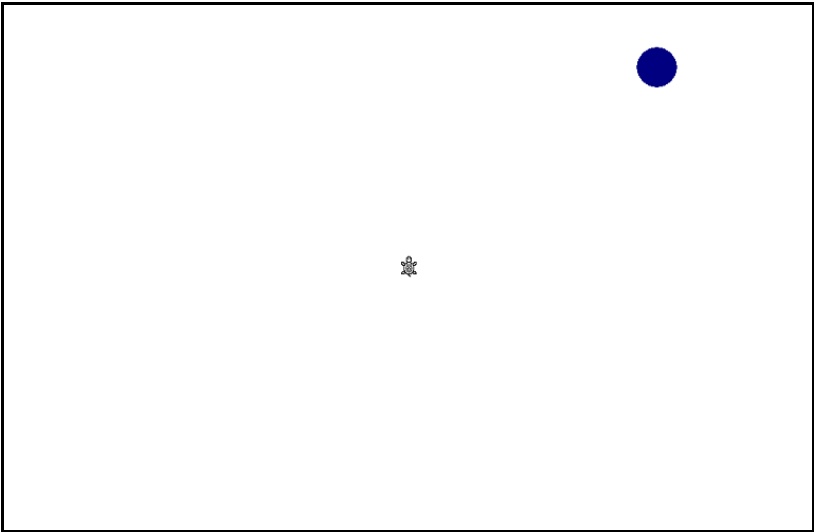



## 5 • Building a Square

Can you draw a square?

Make sure that all the sides have the same number of steps.

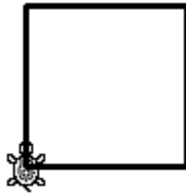

Can you draw a tiny square?

Can you draw a giant square?

## 6 • Making Other Shapes

What other shapes can you draw?

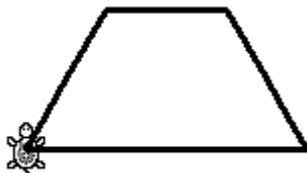
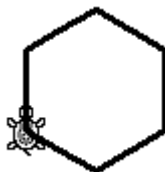
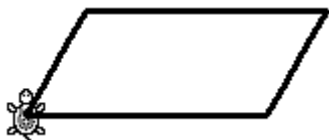
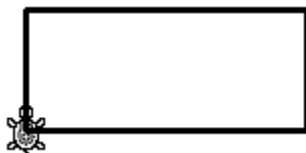
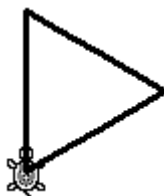
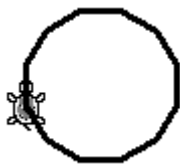

# 7 • Kinderlogo Alphabet

Can you draw letters of the alphabet?  
Some are easy and some are hard.

Can you draw the first letter of your name?

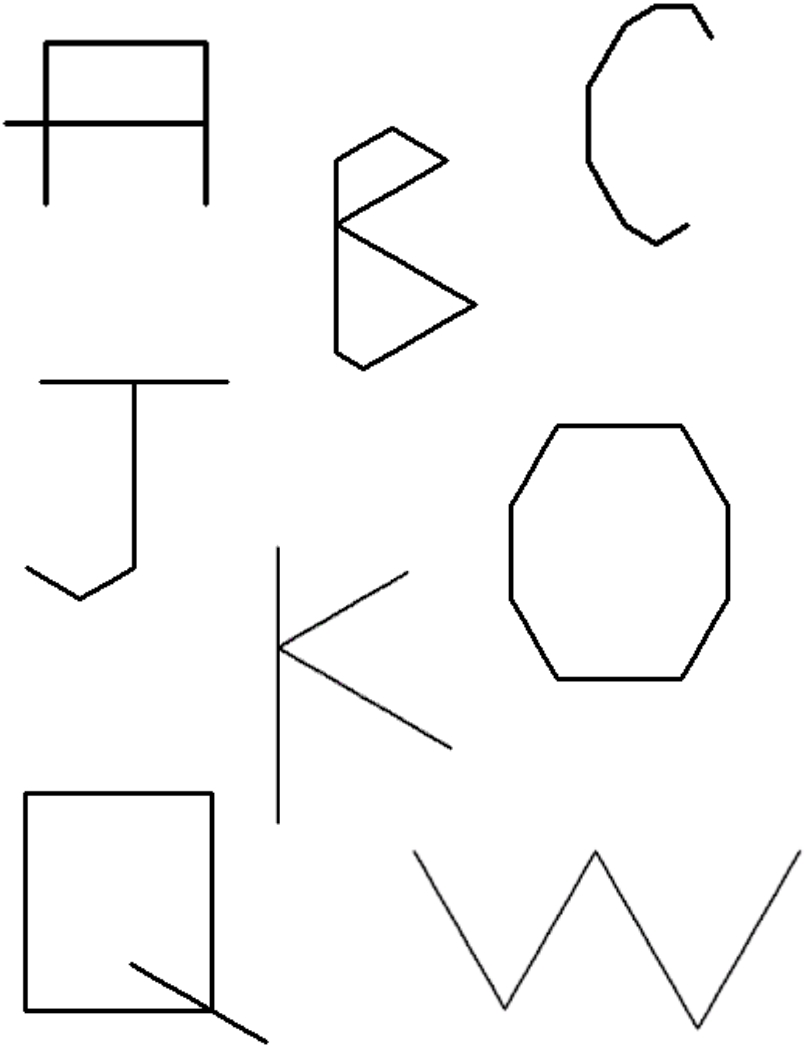

## 8 • Make a Star

Can you draw a star? This is a hard one!

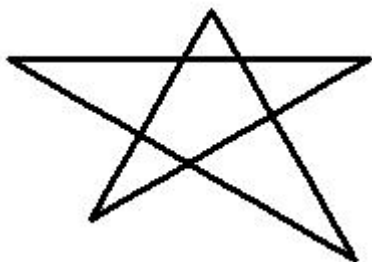
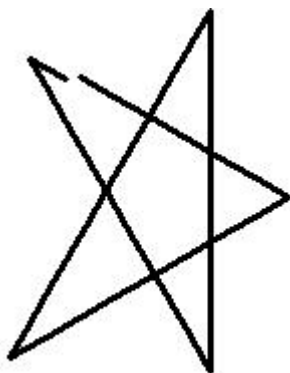
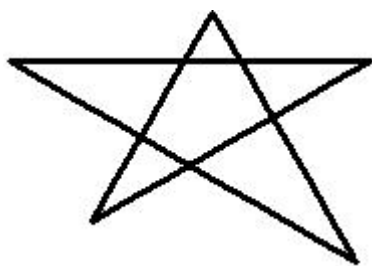
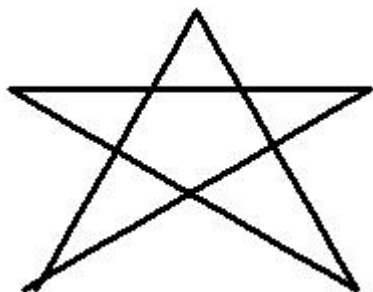
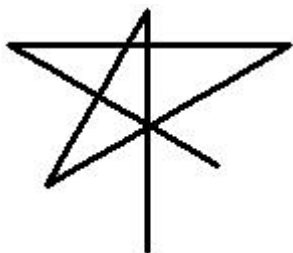

## 9 • Square Corner Day

Can you make a picture with just corners like a square?

How many times do you have to turn the turtle to make a square corner?

Count carefully when you draw your design!

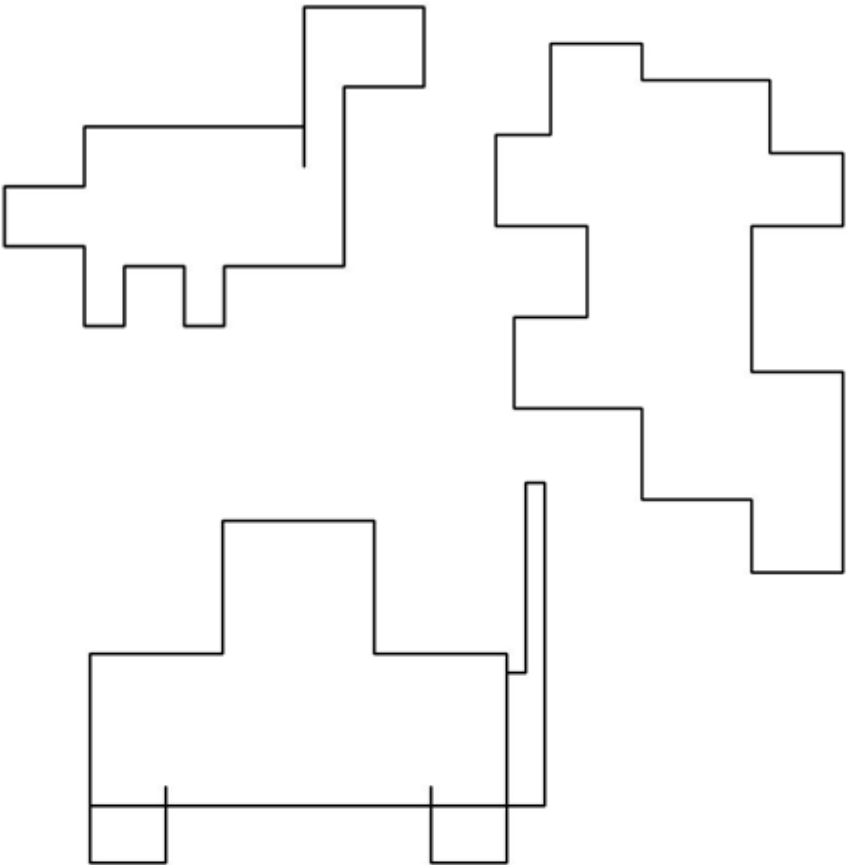

# 10 • Turtle Dance

Have fun with 5 colorful turtles!

Press **D** to see them dance again!

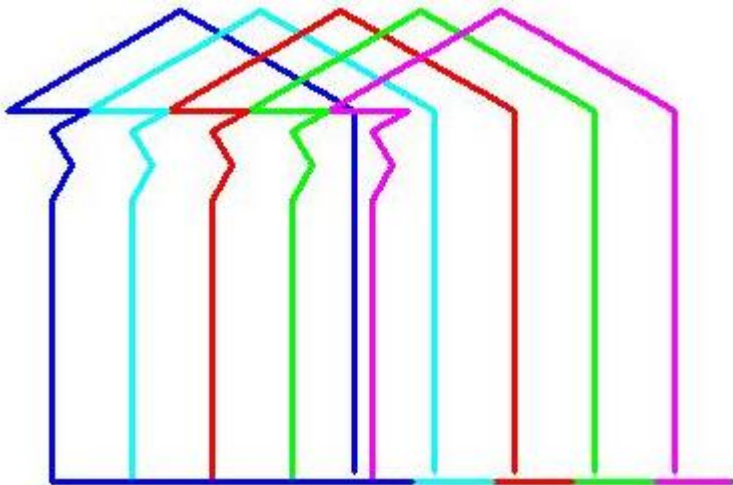
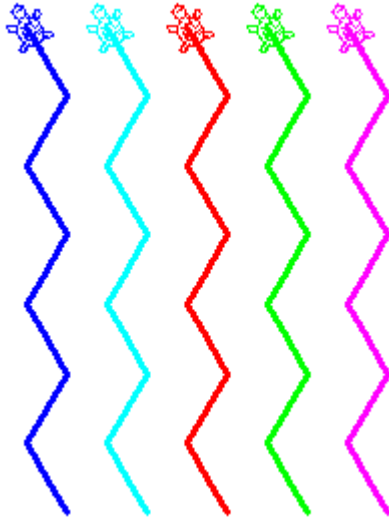



# 11 • Build a House

Can you build a house with the turtle?

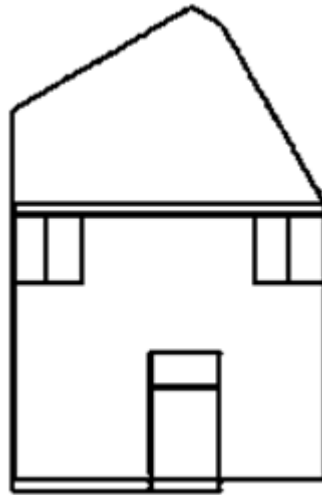
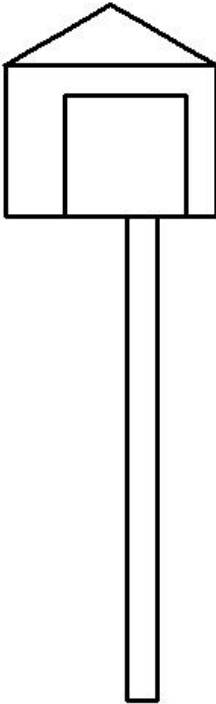
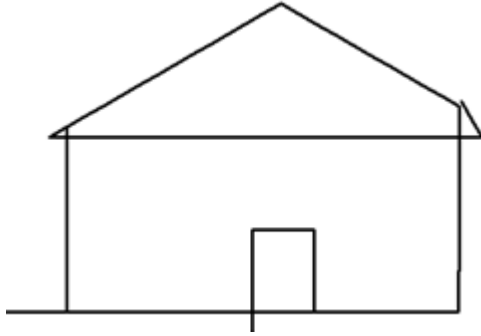

This is a bird house!

## 12 • Color Grid: Explore

Click in a box to color it in.

Press a number key to change the color!

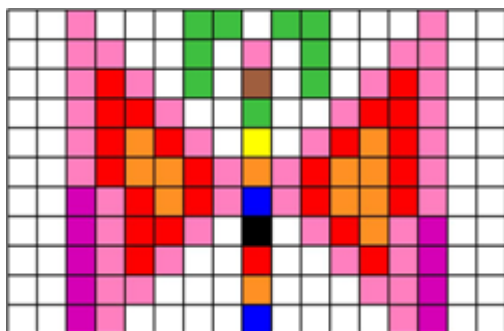
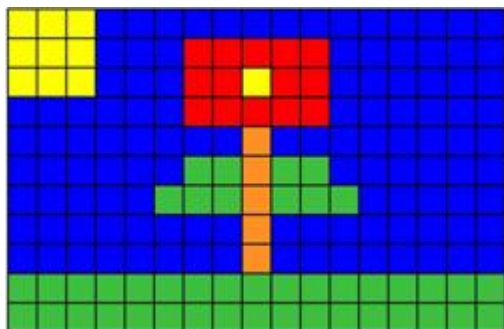

# 13 • Hearts!

Can you draw a heart?

This is a hard shape to draw.

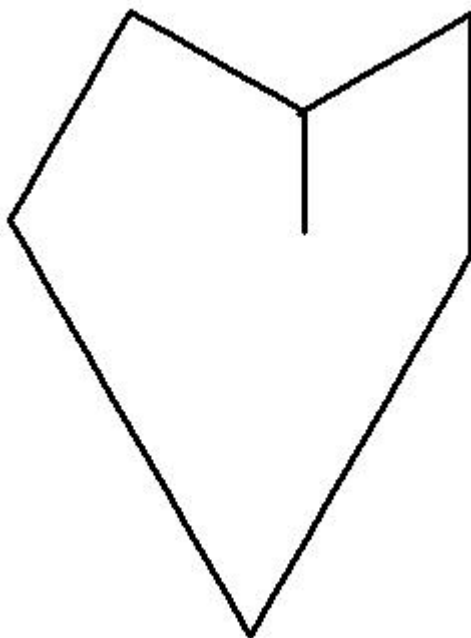
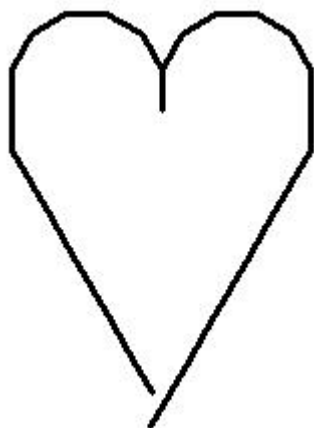
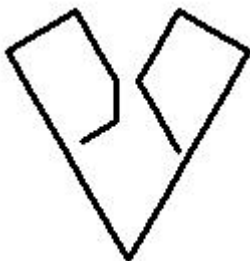
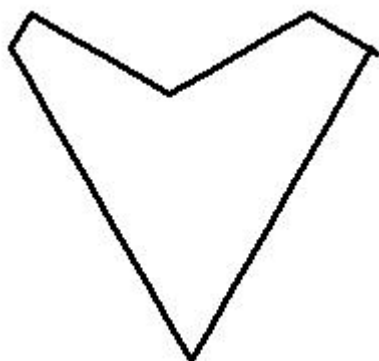

# 14 • Stairs

Can you draw some stairs?

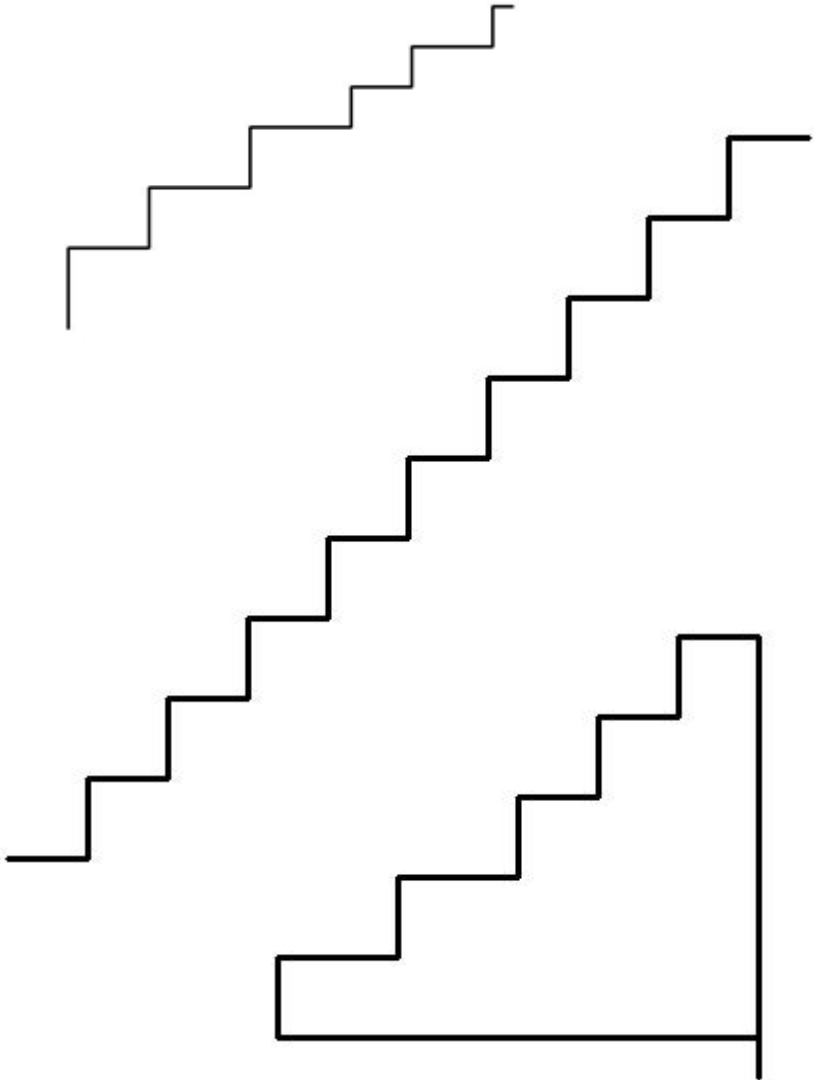

# 15 • Tower of Boxes

Can you draw a tower of boxes?

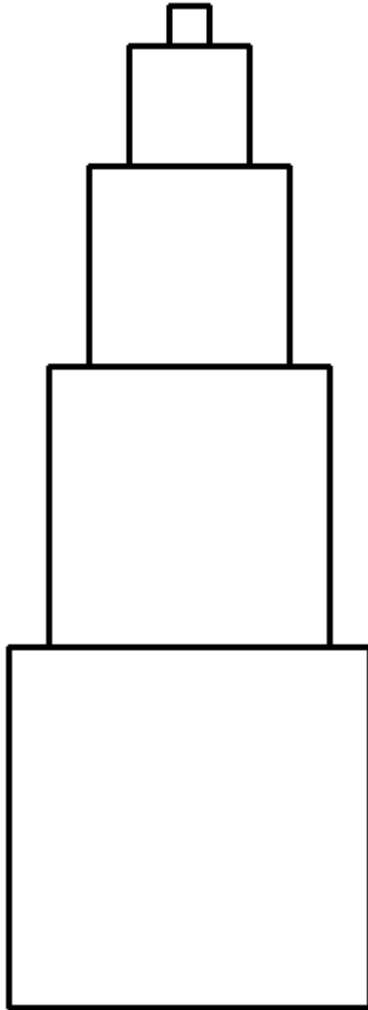

## 16 • Spirals

These are spirals. Can you make one?

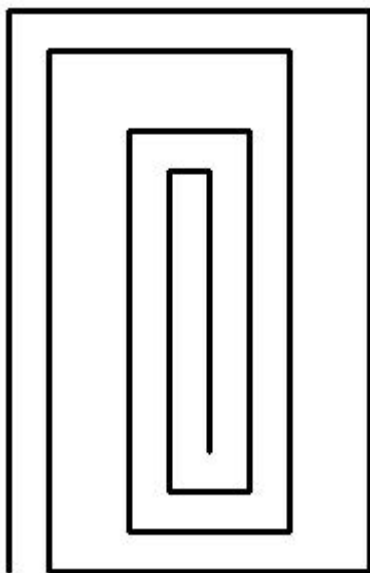
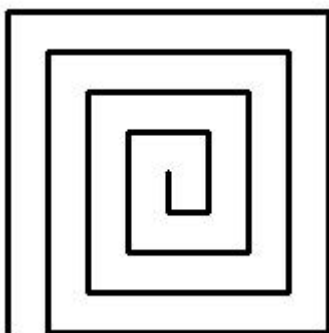
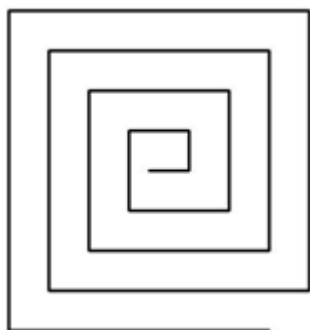

# 17 • Perimeters

Perimeter is the distance around a shape.

Can you draw a square with a  
perimeter of 20?

That means you press **F** 20 times to draw it.

Can you draw a hexagon with a  
perimeter of 18?

Can you draw a triangle with a  
perimeter of 3?

Can you draw a circle with a  
perimeter of 24?

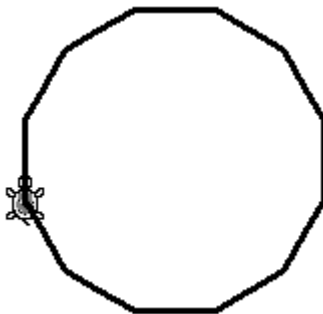

## 18 • Stencil Letters

Can you draw the outline of a letter?

We call it a stencil letter.

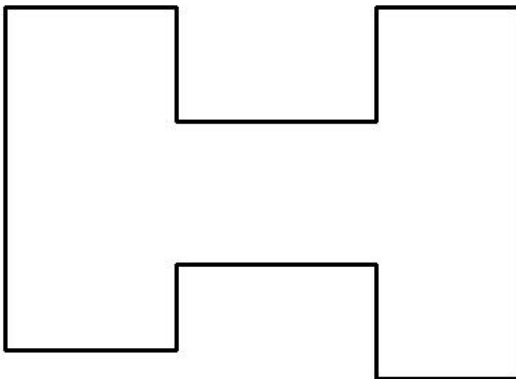
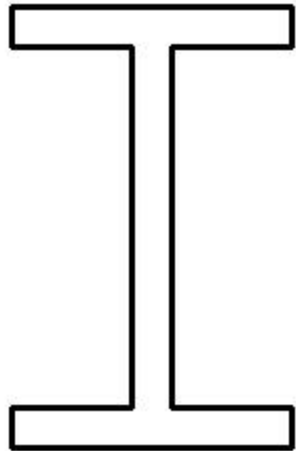
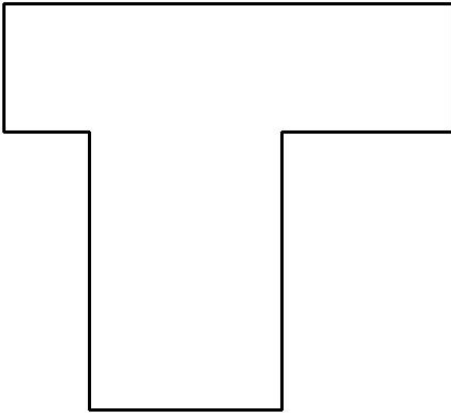





# Level 2 Commands

Here are the new commands at Level 2:

- B**    Back        Move the turtle backward.
- O**    Opposite    Turn the turtle the opposite way.
- S**    Square       Draw a square.
- C**    Circle       Draw a circle.

## 20 • Patterns with Squares

Can you make some patterns with squares?

S R S R ...

S F F F S F F F ...

S F S F ...

S R R S R R ...

S R R R S R R R ...

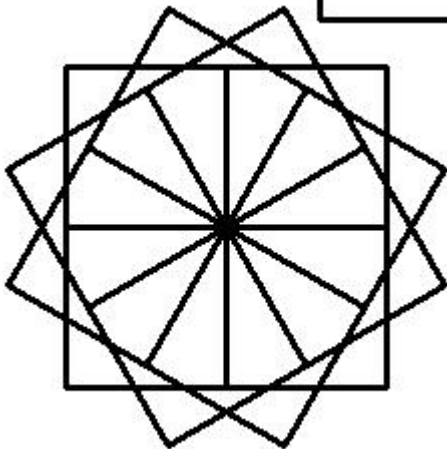
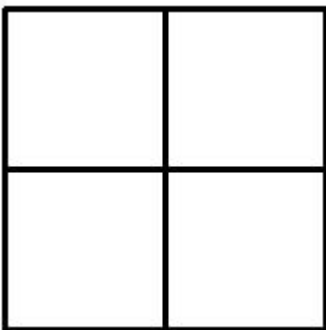
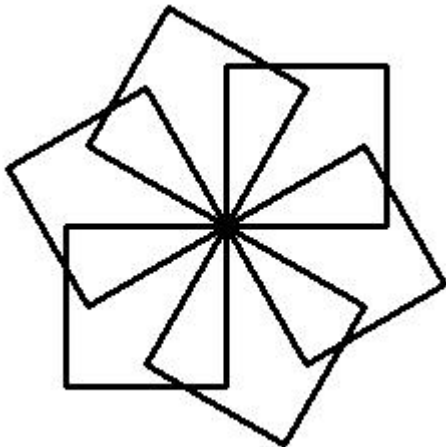

# 21 • Make a Vehicle

What vehicle can you draw with the turtle?

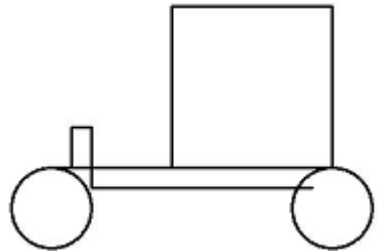
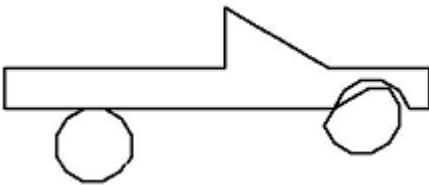
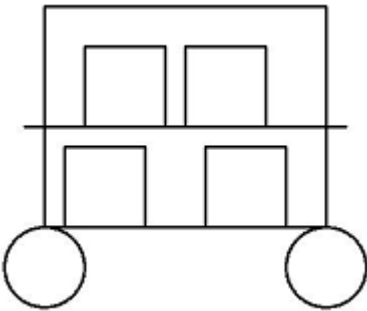
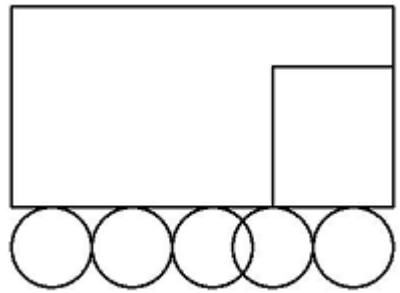
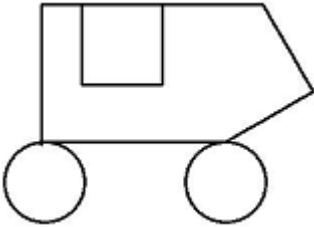
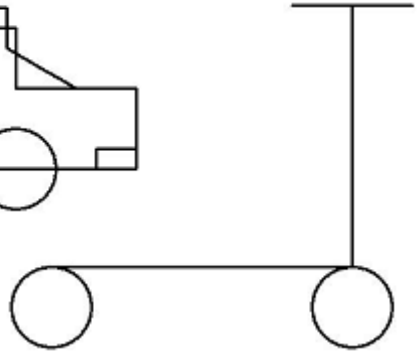
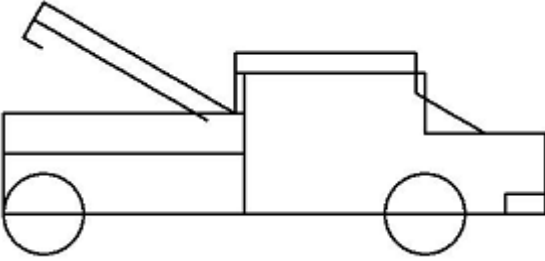

## 22 • Patterns with Circles

Can you make patterns with circles?

CRCR...

CFFCFF...

CFCF...

CRRCRR...

CRRRCRRR...

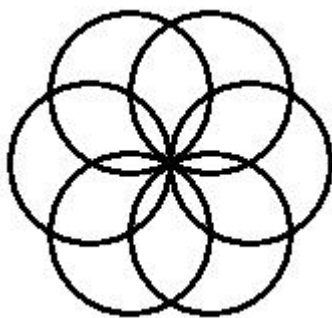
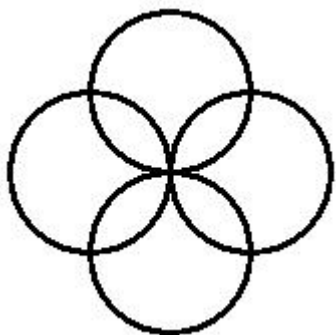
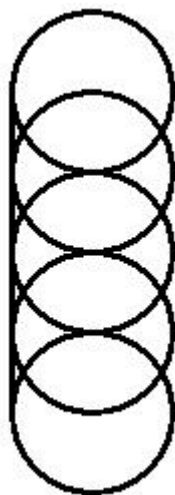
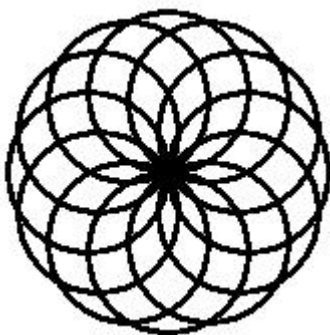
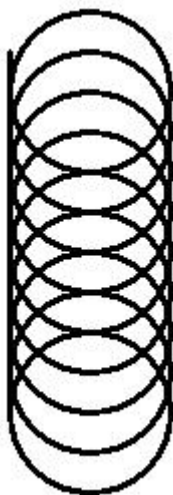

## 23 • Backward Maze

In this maze, the turtle can only go backward.

The **F** key doesn't work!

Good luck!

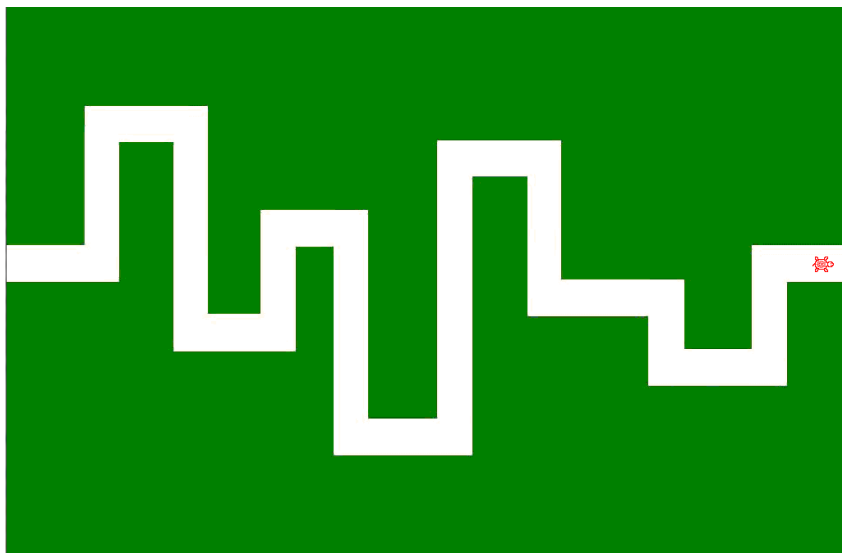

## 24 • Color Grid: Holidays

Make a holiday design with **Color Grid**.

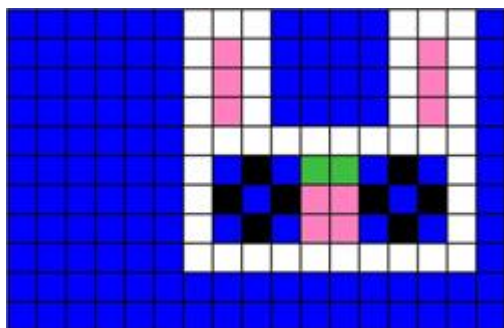

An Easter Rabbit

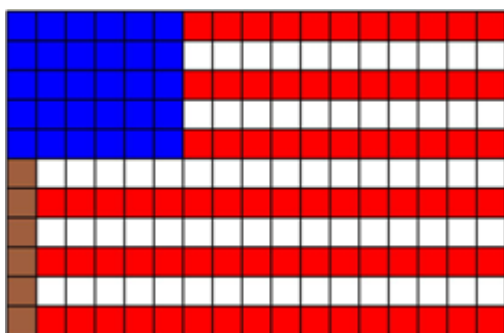

Veterans Day or Memorial Day

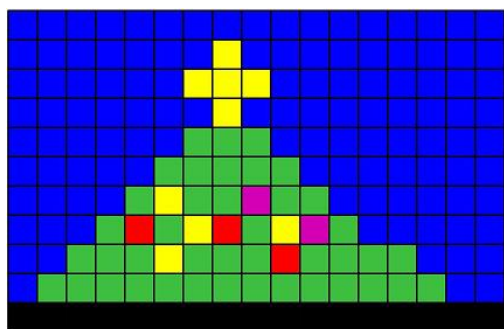

Christmas Magic

## 25 • Stick Figures

Can you draw a stick figure?

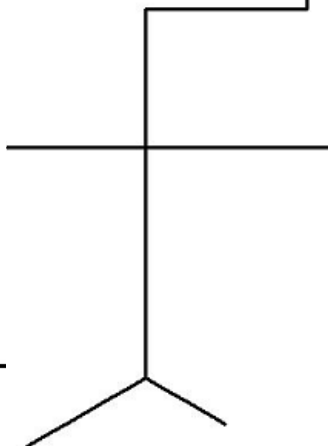
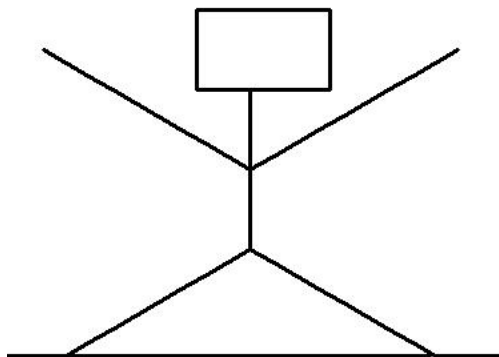
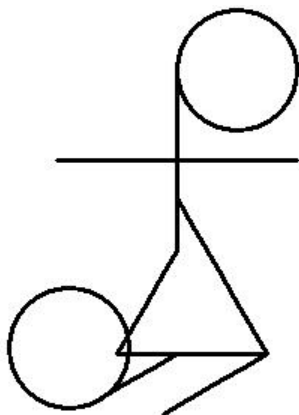
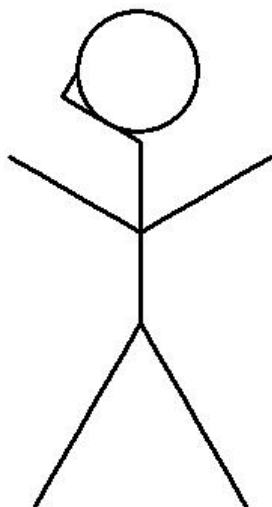
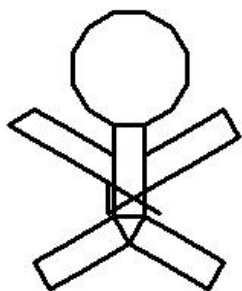



## 26 • Flower Patterns

Use patterns to make some flowers!

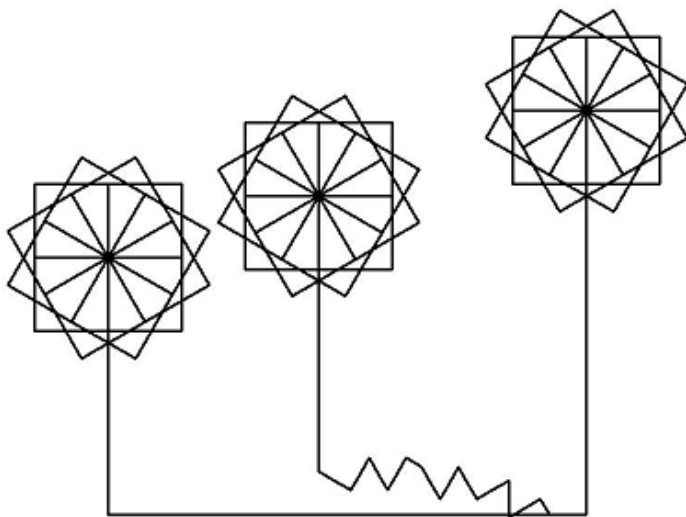
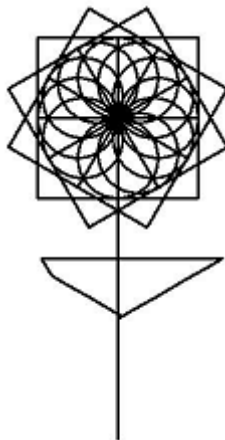
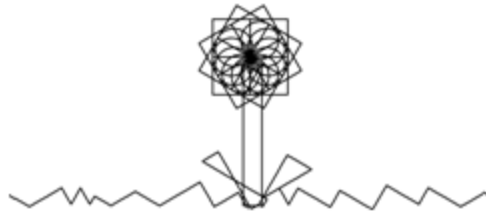

## 27 • Five Squares

How many ways can you connect five squares?

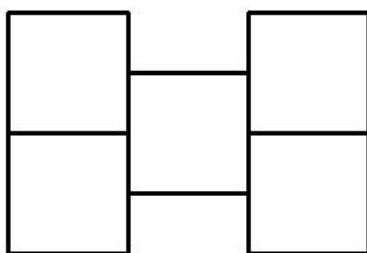
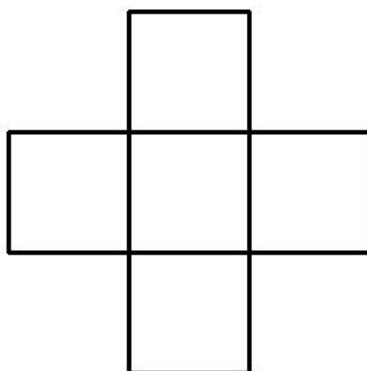
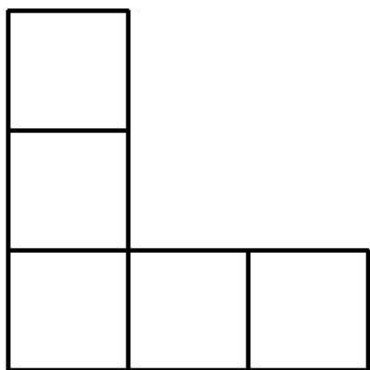
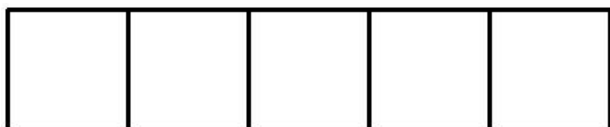

# 28 • Beads

Using **Beads**, you can Copy, Finish, and Create patterns.

Type **S** for a square.

Type **C** for a circle.

Type **T** for a triangle.

Hear a tune when you finish each pattern!

## Copy a Pattern



## Finish a Pattern



## Create a Pattern

1 2 3 4 5 6 7 8



## 29 • Half and Half

Draw a shape, then cut it in half.

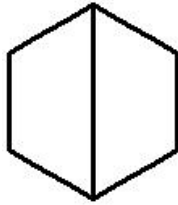
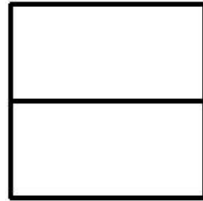
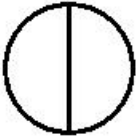

Can you color in half the squares in **Color Grid**? Press a number to set the color.

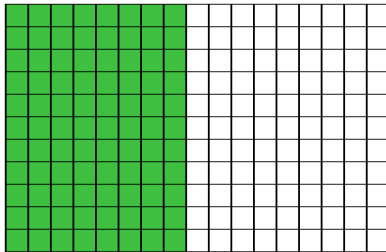

# 30 • Quarters

Draw a shape, then cut it into quarters.

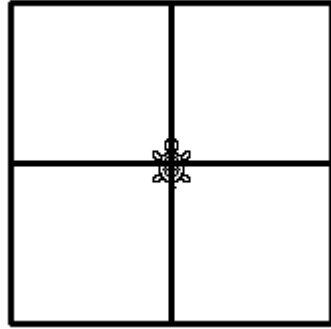
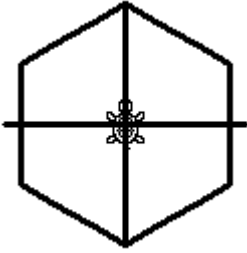

Color in one quarter of the boxes in **Color Grid**.

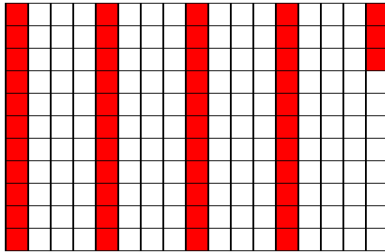

# 31 • A Village

Can you make a village, or a building you would find in a village?

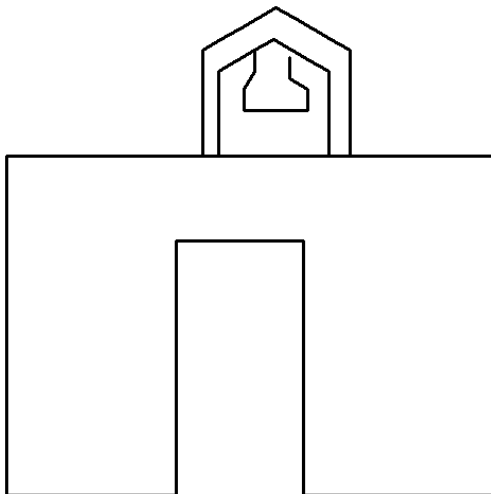
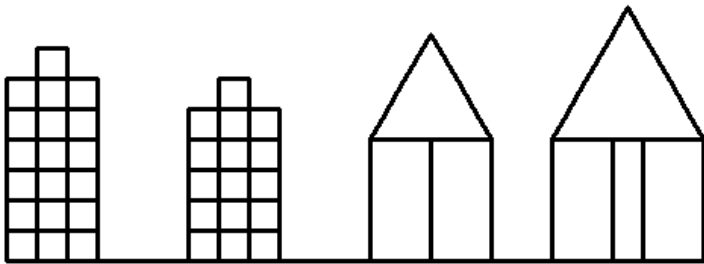
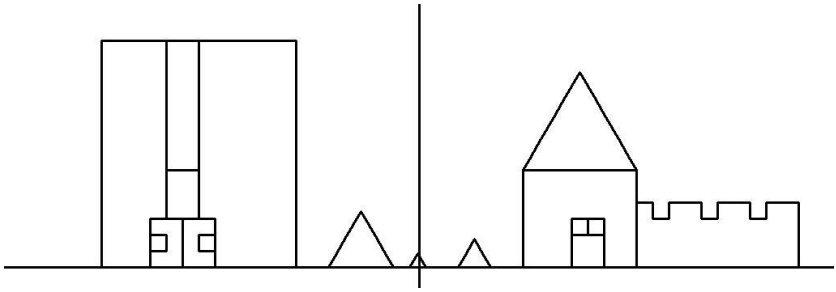

## 32 • Letter Dots

Connect the dots to make a letter.

Then type the letter you drew.

Some are easy!

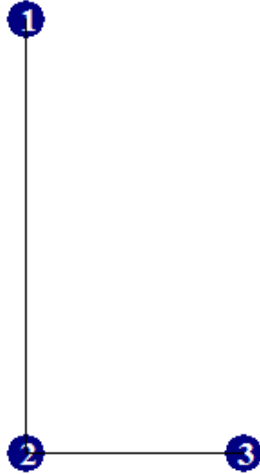

Some are harder.

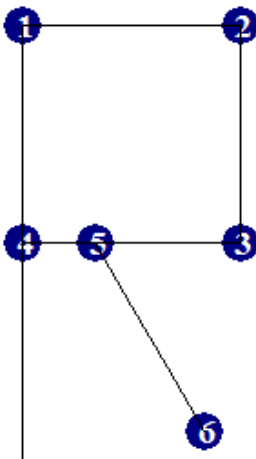

## Level 3 Commands

- U** Up Picks up the turtle's pen so it cannot draw when it moves.
- D** Down Puts the turtle's pen back down so it can draw again.
- T** Turtle Hides or shows the turtle.
- H** Home Moves the turtle to its Home, in the middle of the screen.



## 33 • Hello, My Name Is...

Can you write your name with the turtle?  
Press **U** to pick up the pen between letters.  
Press **D** when you want to draw again.

A la hi o

A l e x

L u i s

# 34 • Patterns Everywhere!

Put your favorite patterns all over the screen! Press **U** to pick up the pen between letters. Press **D** to draw again.

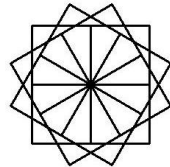
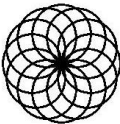
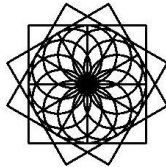
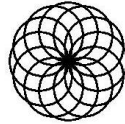
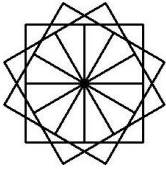
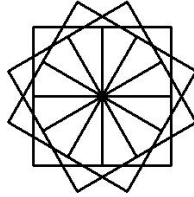
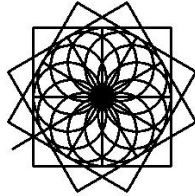
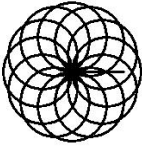

# 35 • Animals

What animal can you try to draw?

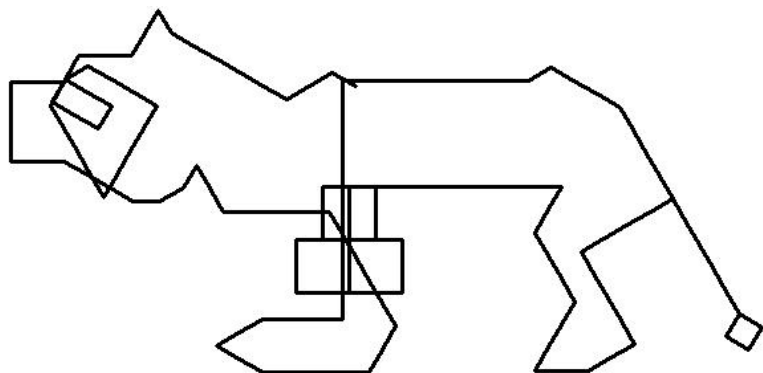
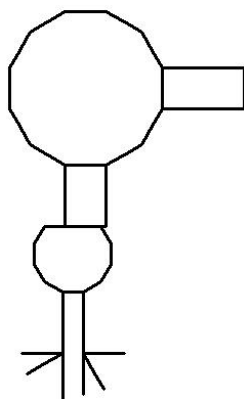
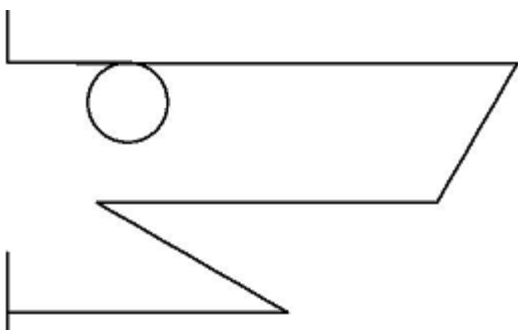
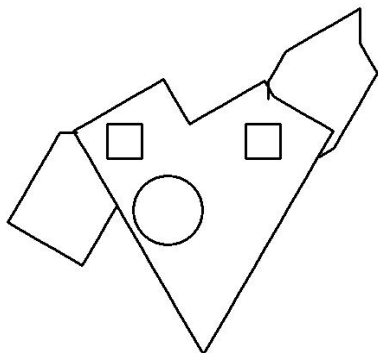
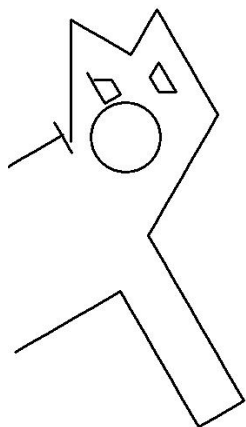

# 36 • Free Time

Just have fun with the turtle. Draw anything you want!

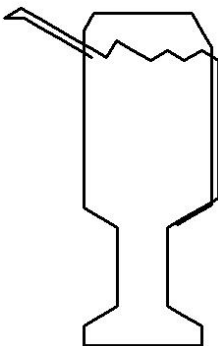
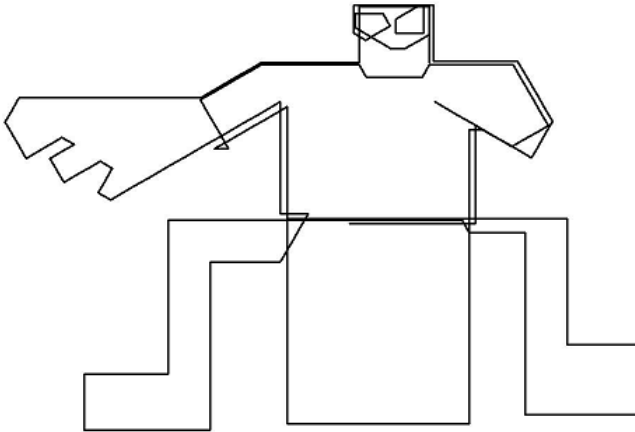
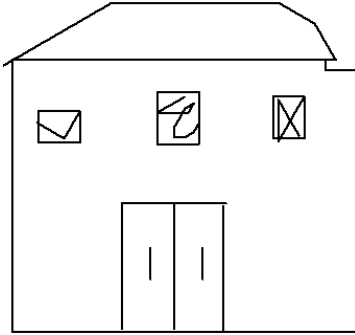

## 37 • Target Game

**Target** is like Balloon. But you can't see the turtle. It is invisible!

Good luck!

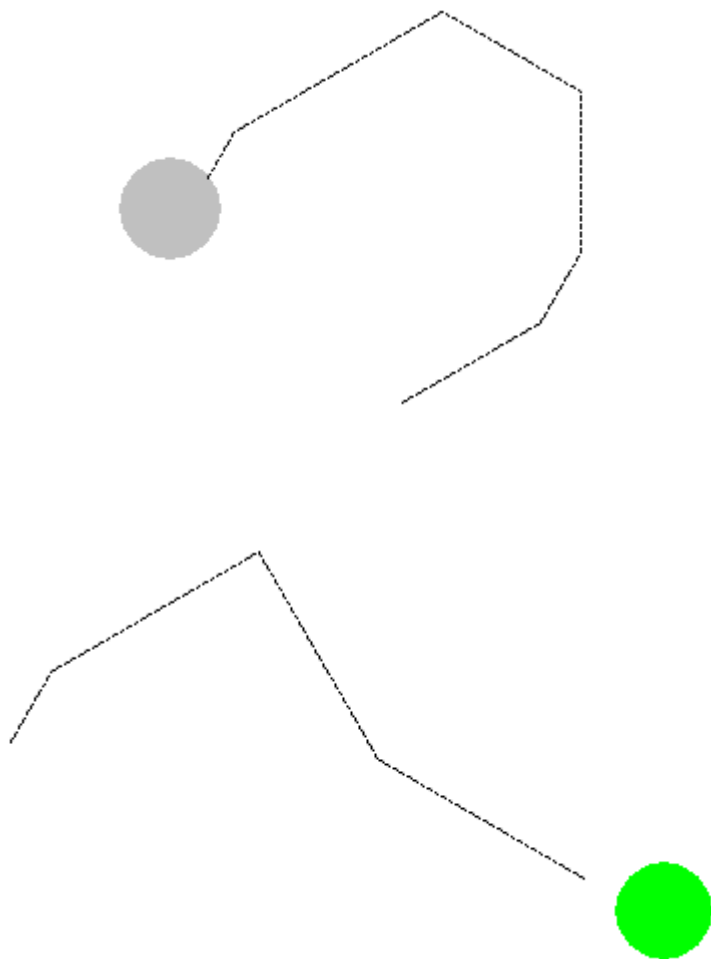

## 38 • Tic-Tac-Toe

Do you know how to play Tic-Tac-Toe?  
You can play it with the turtle. Maybe a  
friend can play with you.

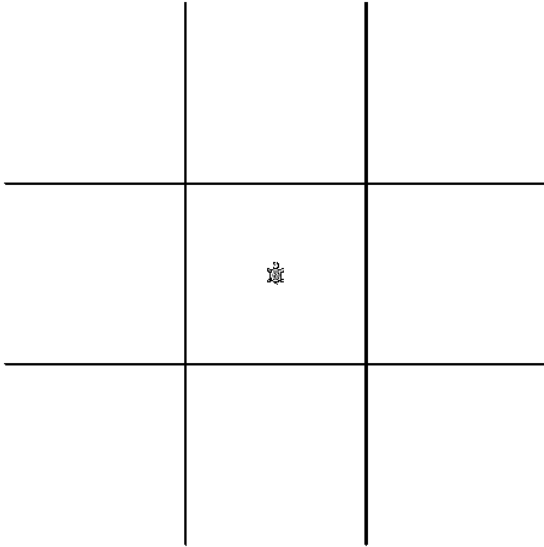

Press **U** to pick up the turtle's pen.

Move the turtle to a box.

Press **D** to put the pen back down.

Press **O** to mark it with a circle.

Press **X** to mark it with a square.

# Level 4 Commands

## Pen Colors:

Type the number to change the color of the turtle's pen.

|                 |                 |                |
|-----------------|-----------------|----------------|
| <b>0</b> White  | <b>1</b> Black  | <b>2</b> Red   |
| <b>3</b> Orange | <b>4</b> Yellow | <b>5</b> Green |
| <b>6</b> Blue   | <b>7</b> Purple | <b>8</b> Pink  |
| <b>9</b> Brown  |                 |                |

**I** Ink on Starts filling squares (**S**) and circles (**C**).  
(**I** is the first letter of Ink.)

**K** Ink off Stops filling squares (**S**) and circles (**C**).  
(**K** is the last letter of Ink.)

**P** Paint Fills in the background of the area around the turtle.

## 39 • Colored Lines

Press a number to set the color of the turtle's pen.

Then have fun drawing pictures in color!

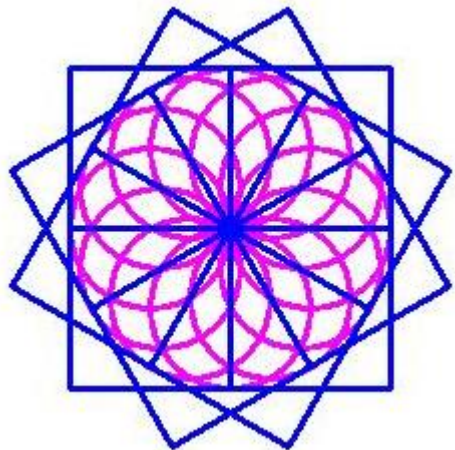
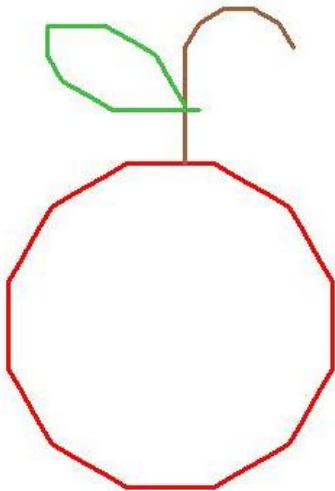
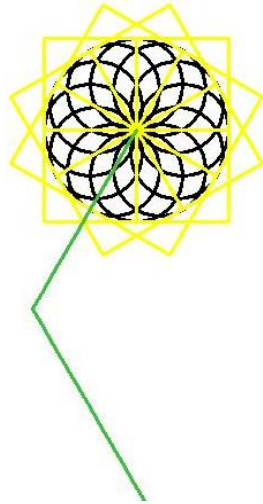
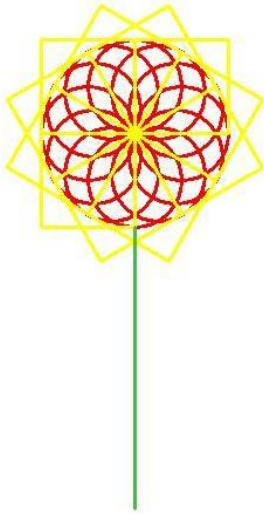



# 40 • Colored Shapes

Try the **I** and **K** commands. **I** turns “ink” on and **K** turns it off. Use these commands to fill in circles (**C**) and squares (**S**).

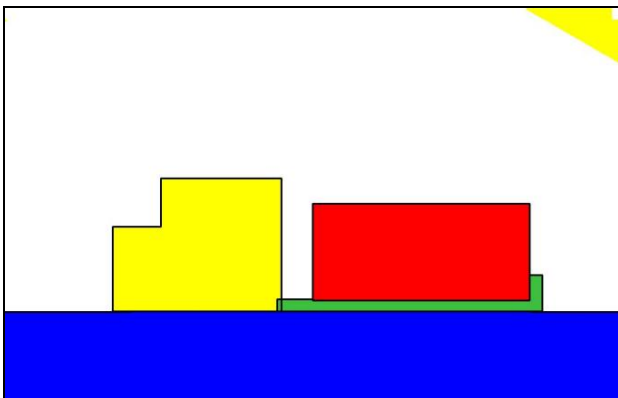
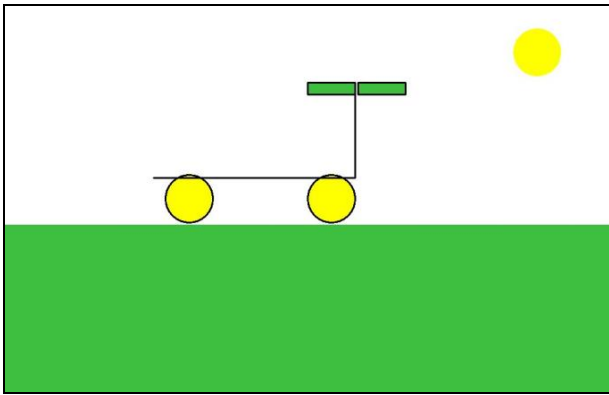
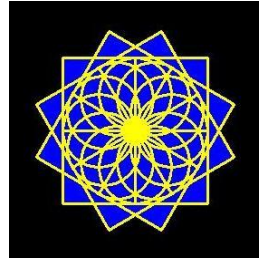
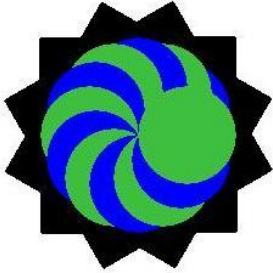

## 41 • Multiplication & Area

Can you make a rectangle with 24 boxes?

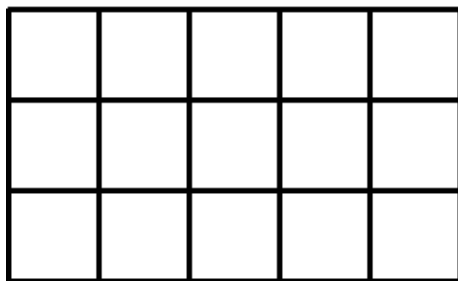

This number is called the area.

It is a 4 x 6 box.

Can you make other rectangles and find their areas?

How about 3 x 5?      8 x 2?      4 x 1?

How many can you make?

## 42 • Flags of the World

Find pictures of flags from different countries.

Can you draw a flag with the turtle?



Ethiopia



Antarctica



Sweden



Dominican Republic

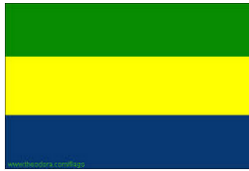

Gabon

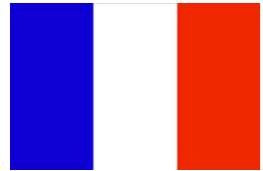

France

Find your country on a map of the world.

Learn a fact about the country.

## 43 • Mirror

In **Mirror** two turtles move together when you type **F** or **B**. But when you type **R** or **L**, they turn in opposite ways. You can add color, too!

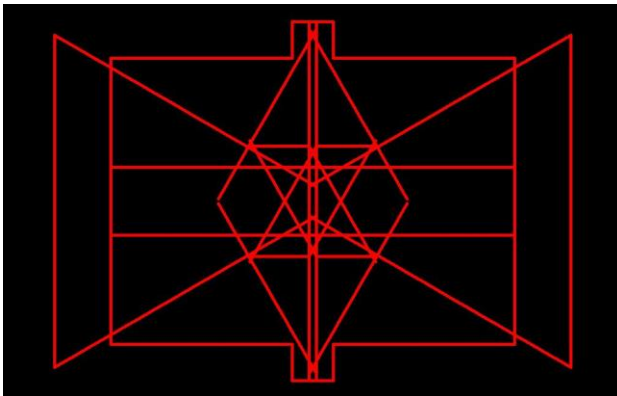
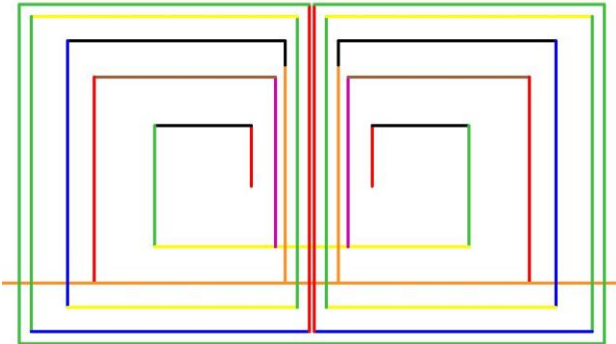
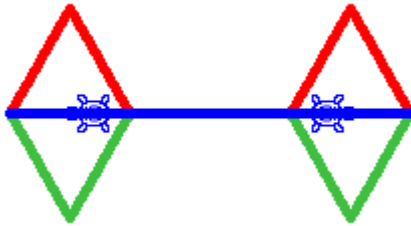

## 44 • Turtle Time

Can the turtle tell time? Well, not really, but you can draw clock hands to show times.

Start by choosing an hour. Don't forget to make the hour hand short and the minute hand long. Can you tell what time this is?



Next, try a harder time.

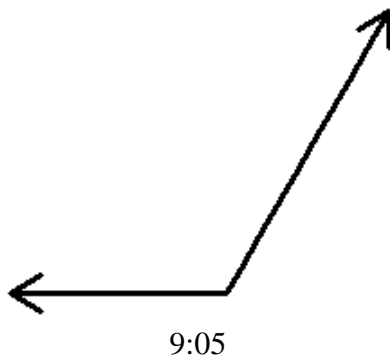

Press **H** to move the turtle to the center of the screen.

# 45 • Color Grid: Graph Paper

Get a piece of graph paper. Mark off a box that is 17 boxes across and 11 boxes down.

Now draw a picture on the graph paper by coloring in the boxes.

When you are done, draw the same picture in **Color Grid**.

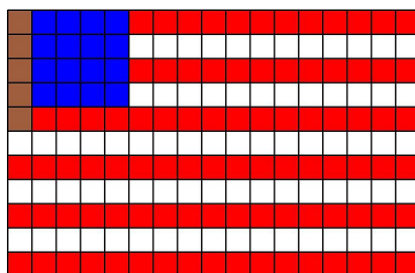
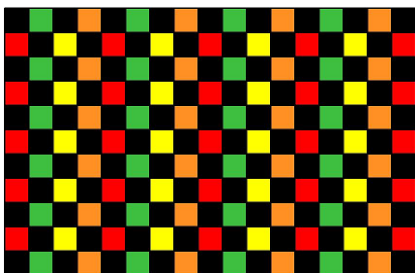
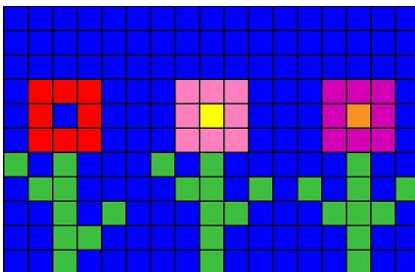
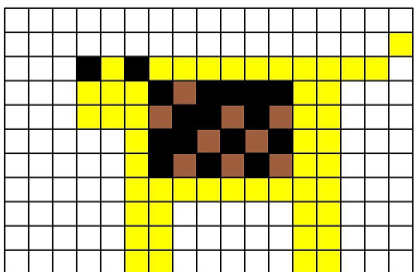
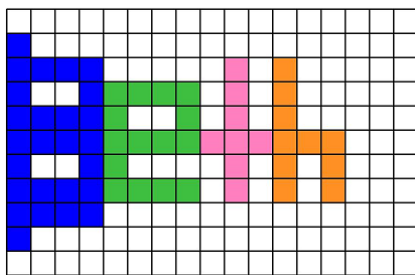
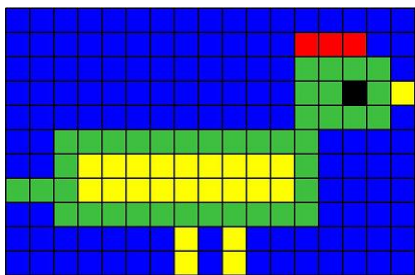

# 46 • Lollipops!

How many colorful lollipops can you draw?

Use the **I** command to fill in the circles automatically.

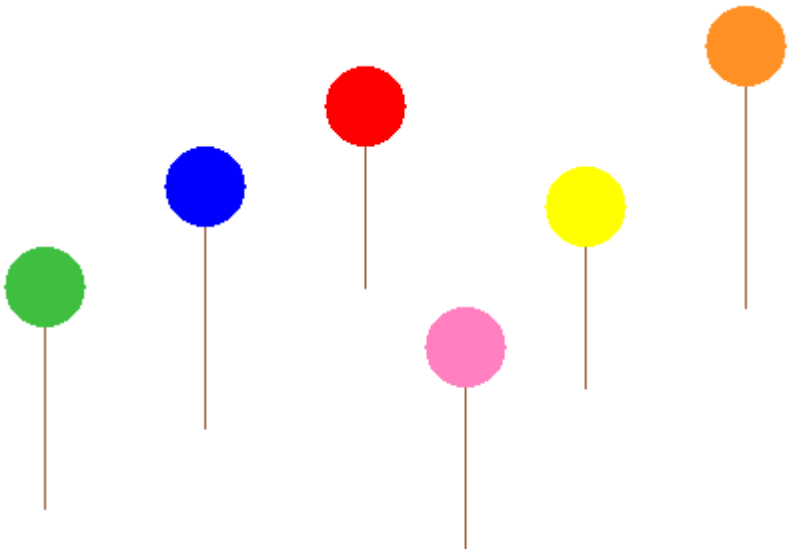

What flavor is each lollipop?

Which one is your favorite?

How can you make a black border around your lollipop?

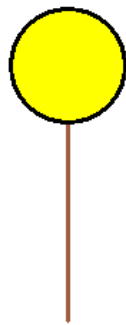

## 47 • Symmetry

In **Symmetry** you can explore 2 lines of symmetry. This time you have four turtles. They move in the same direction when you press **F** or **B**. But when you type **R** or **L**, they turn in opposite directions. You can use color, too!

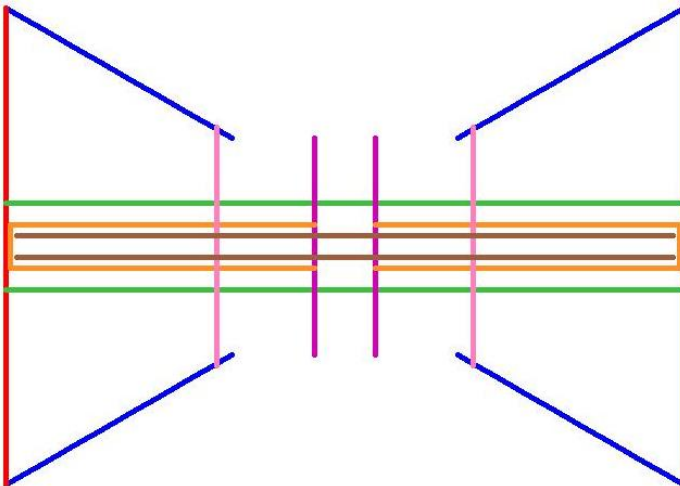
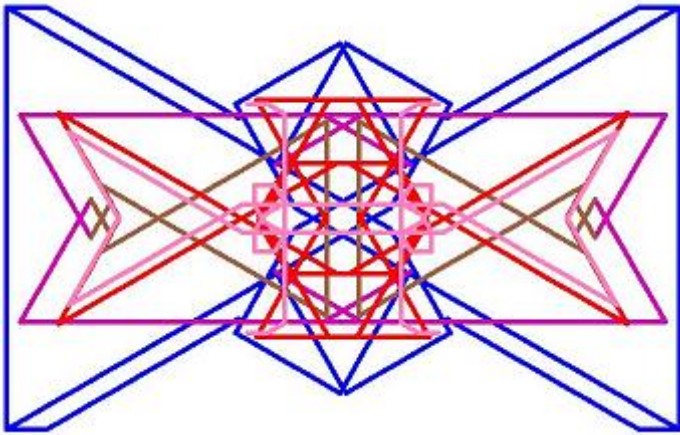



## Level 5 Commands

In Level 5, you can teach the turtle how to draw a picture and then draw it whenever you want.

Here are the new commands at Level 5.

**A, G, M,** Save your picture with a  
or **Z** letter name.

**E** Erase a picture stored by a  
Letter name.

# 48 • Sizes

Now you can make shapes any size you want! Use the **Sizes** activity.

Press a letter to draw a shape:

**C** – Circle      **T** – Triangle  
**S** – Square      **H** – Hexagon

Type a number for the size you want and click OK.

What size circle?

OK

Cancel

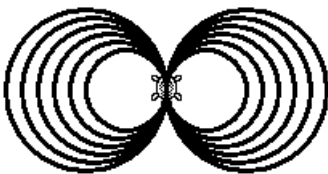

Can you draw this?

Then this?

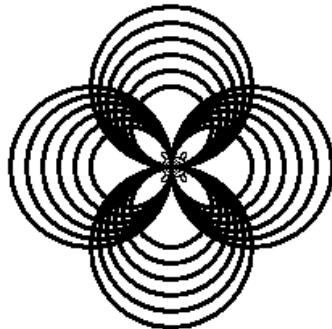

## 49 • Teach the Turtle

Draw a design, then save it. To save it, press **A**, **G**, **M**, or **Z**. Then type the same letter again to draw your picture anywhere you want!

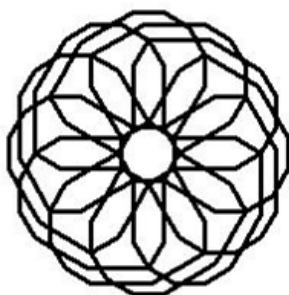
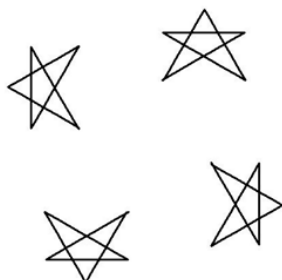
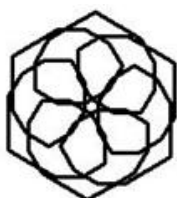
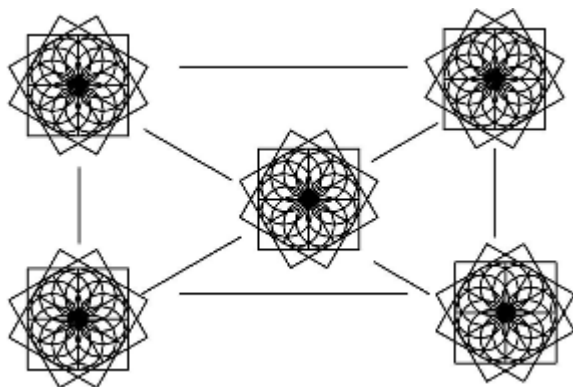

## 50 • Picture Pairs

Save the picture you drew first. (Ask an adult for help.) Then make a picture using that little design and save it, too!

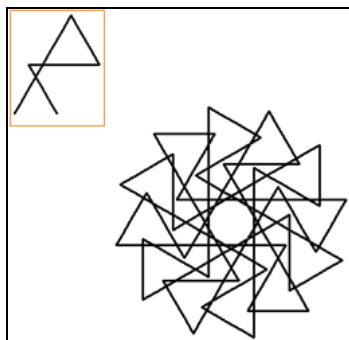
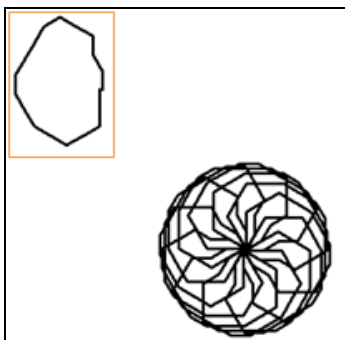
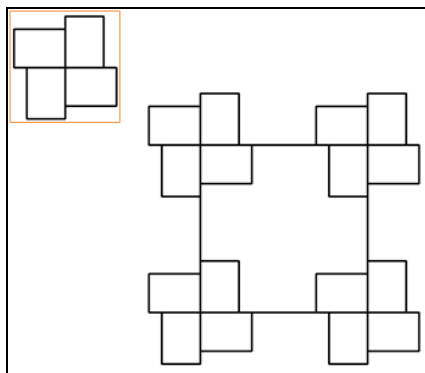
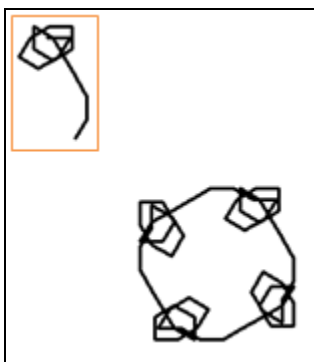
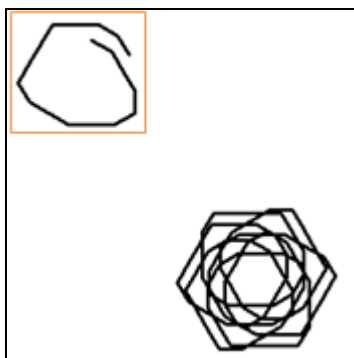
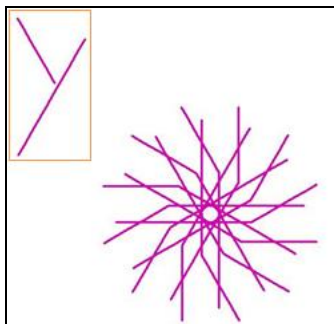

## 51 • Logic Game

In **Guess**, you will try to guess the shape that the computer is thinking of. Press letters to guess the size, color and shape.

**Size:** Small, Medium, Large

**Color:** Red, Yellow, Green, Blue, Purple

**Shape:** Triangle, Square, Hexagon,  
Octagon, Circle

The turtle will draw the shape you guessed. It tells you if you were right. Press the space bar to make another guess.

RED



SMALL RED



Now, can you guess the right shape!

## 52 • Snowflakes

Look at these snowflake designs. Which part can you teach the turtle how to draw? Can you make these snowflakes? Make some snowflakes of your own!

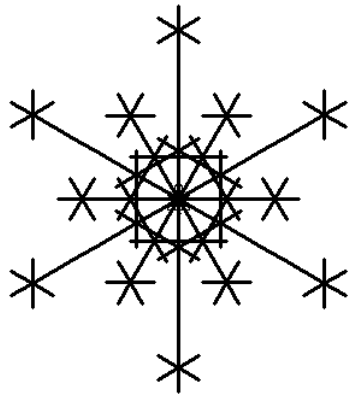
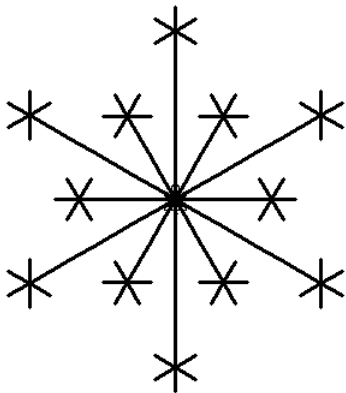
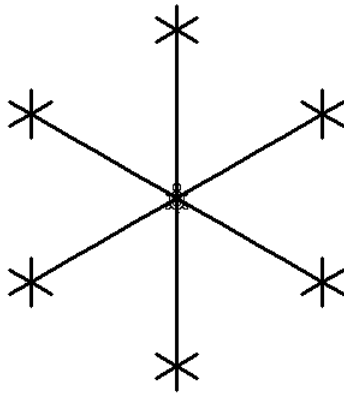

# Student Name \_\_\_\_\_

## Level 1

- 1. Meet the Turtle
- 2. Exploring with the Turtle
- 3. Balloon Game
- 4. Mazes
- 5. Building a Square
- 6. Making Other Shapes
- 7. Kinderlogo Alphabet
- 8. Make a Star
- 9. Square Corner Day
- 10. Turtle Dance
- 11. Build a House
- 12. Color Grid: Explore
- 13. Hearts!
- 14. Stairs
- 15. Tower of Boxes
- 16. Spirals
- 17. Perimeters
- 18. Stencil Letters
- 19. Snaky Curves

## Level 2

- 20. Patterns with Squares
- 21. Make a Vehicle
- 22. Patterns with Circles
- 23. Backward Maze
- 24. Color Grid: Holidays
- 25. Stick Figures
- 26. Flower Patterns
- 27. Five Squares
- 28. Beads

- 29. Half and Half
- 30. Quarters
- 31. A Village
- 32. Letter Dots

## Level 3

- 33. Hello, My Name Is...
- 34. Patterns Everywhere!
- 35. Animals
- 36. Free Time
- 37. Target Game
- 38. Tic-Tac-Toe

## Level 4

- 39. Colored Lines
- 40. Colored Shapes
- 41. Multiplication & Area
- 42. Flags of the World
- 43. Mirror
- 44. Turtle Time
- 45. Graph Paper
- 46. Lollipops!
- 47. Symmetry

## Level 5

- 48. Sizes
- 49. Teach the Turtle
- 50. Picture Pairs
- 51. Logic Game
- 52. Snowflakes

# Student Name \_\_\_\_\_

## Level 1

- 1. Meet the Turtle
- 2. Exploring with the Turtle
- 3. Balloon Game
- 4. Mazes
- 5. Building a Square
- 6. Making Other Shapes
- 7. Kinderlogo Alphabet
- 8. Make a Star
- 9. Square Corner Day
- 10. Turtle Dance
- 11. Build a House
- 12. Color Grid: Explore
- 13. Hearts!
- 14. Stairs
- 15. Tower of Boxes
- 16. Spirals
- 17. Perimeters
- 18. Stencil Letters
- 19. Snaky Curves

## Level 2

- 20. Patterns with Squares
- 21. Make a Vehicle
- 22. Patterns with Circles
- 23. Backward Maze
- 24. Color Grid: Holidays
- 25. Stick Figures
- 26. Flower Patterns
- 27. Five Squares
- 28. Beads

- 29. Half and Half
- 30. Quarters
- 31. A Village
- 32. Letter Dots

## Level 3

- 33. Hello, My Name Is...
- 34. Patterns Everywhere!
- 35. Animals
- 36. Free Time
- 37. Target Game
- 38. Tic-Tac-Toe

## Level 4

- 39. Colored Lines
- 40. Colored Shapes
- 41. Multiplication & Area
- 42. Flags of the World
- 43. Mirror
- 44. Turtle Time
- 45. Graph Paper
- 46. Lollipops!
- 47. Symmetry

## Level 5

- 48. Sizes
- 49. Teach the Turtle
- 50. Picture Pairs
- 51. Logic Game
- 52. Snowflakes